

Typical Performance

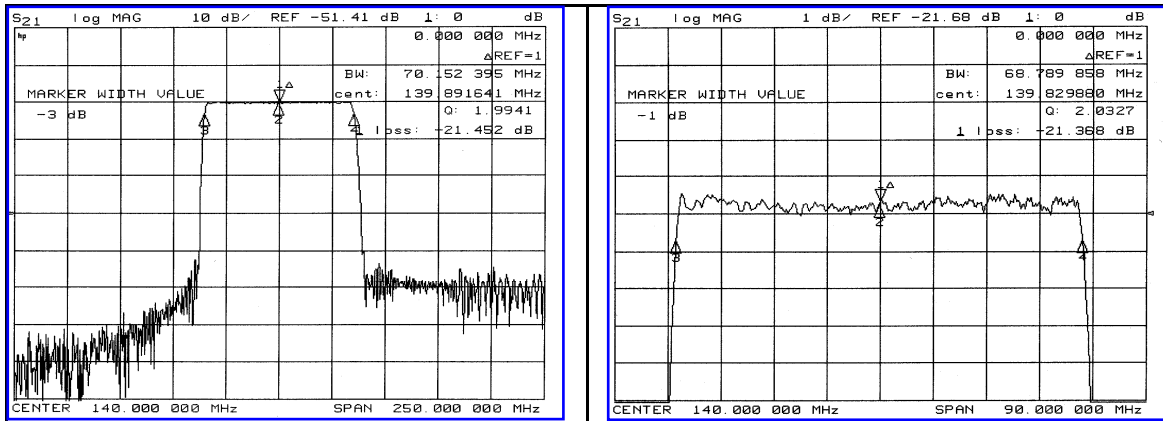

Specification

Parameter	Unit	Min.	Typ.	Max.
Center Frequency	MHz	139.80	140.00	140.20
Insertion Loss	dB	-	22.00	24.00
1dB Bandwidth	MHz	-	68.78	-
3dB Bandwidth	MHz	69.90	70.15	-
40dB Bandwidth	MHz	-	76.88	77.50
Passband Ripple	dB	-	0.65	1.00
Group Delay Variation	nsec	-	50	100
Absolute Delay	µsec	-	0.71	-
Ultimate Attenuation	dB	40	45	-
Substrate Material	-	YZ-LiNbO ₃		
Temperature Coefficient	ppm/°C	-86		

Package Dimension

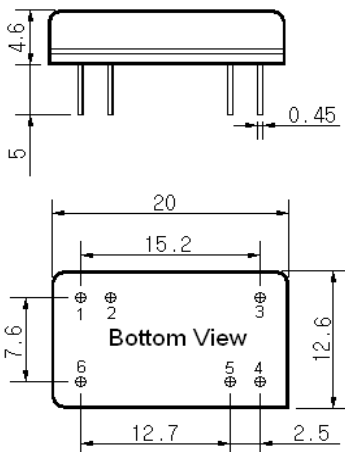

Matching Configuration

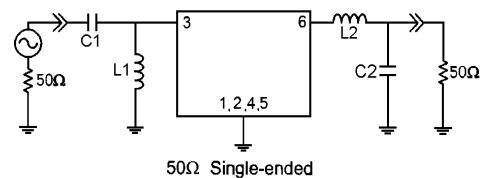

L1=27nH, L2=33nH, C1=68pF, C2=27pF
 Source / Load Impedance = 50Ω
 Ambient Temperature = 25°C

12/29/2005

