

Typical Performance

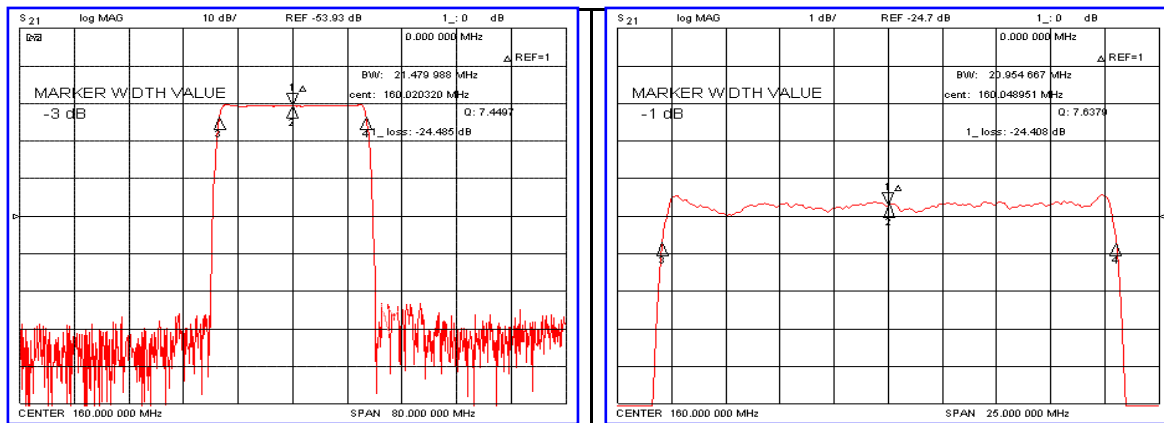

Specification

Parameter	Unit	Min.	Typ.	Max.
Center Frequency (Fc)	MHz	-	160.00	-
Insertion Loss	dB	-	24.50	26.00
1dB Bandwidth	MHz	-	20.95	-
3dB Bandwidth	MHz	21.00	21.47	-
40dB Bandwidth	MHz	-	23.81	24.00
Passband Ripple (Fc±9.75MHz)	dB	-	0.55	1.00
Group Delay Variation (Fc±9.75MHz)	nsec	-	28	50
Absolute Delay	µsec	-	1.48	-
Ultimate Attenuation	dB	50	55	-
Substrate Material	-	128-LiNbO ₃		
Temperature Coefficient	ppm/°C	-72		

Package Dimension

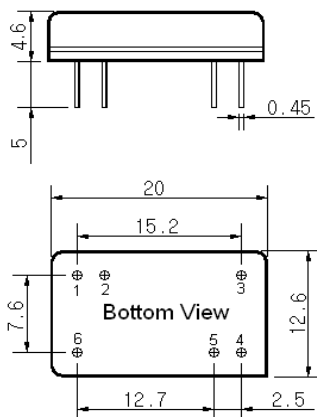

Matching Configuration

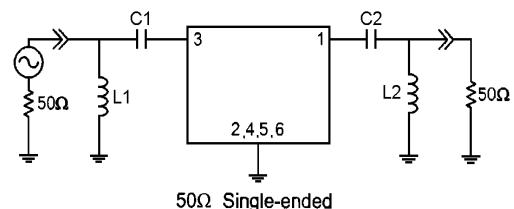

L1 = L2 = 82nH, C1 = C2 = 47pF
 Source / Load Impedance = 50Ω
 Ambient Temperature = 25°C

07/26/2006

