

Typical Performance

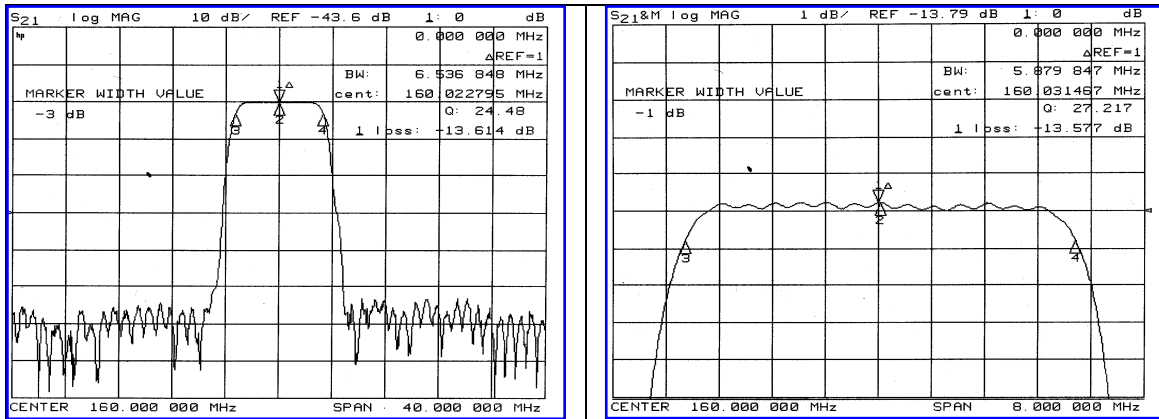

Specification

Parameter	Unit	Min.	Typ.	Max.
Center Frequency	MHz	159.85	160.00	160.15
Insertion Loss	dB	-	13.50	15.00
1dB Bandwidth	MHz	-	5.87	-
3dB Bandwidth	MHz	6.00	6.53	-
40dB Bandwidth	MHz	-	9.09	9.30
Passband Ripple	dB	-	0.35	1.00
Group Delay Variation	nsec	-	80	150
Absolute Delay	µsec	-	1.25	-
Ultimate Attenuation	dB	40	50	-
Substrate Material	-	LiTaO ₃		
Temperature Coefficient	ppm/°C	-20		

Package Dimension

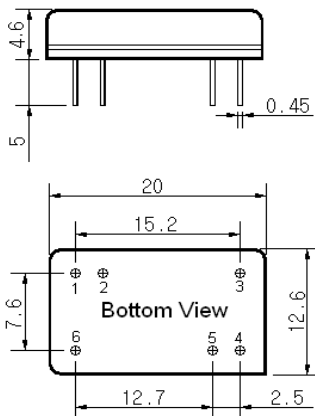

Matching Configuration

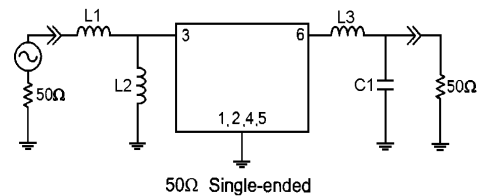

L1=33nH, L2=47nH, L3=33nH, C1=30pF
 Source / Load Impedance = 50Ω
 Ambient Temperature = 25°C

01/03/2006

