

Typical Performance

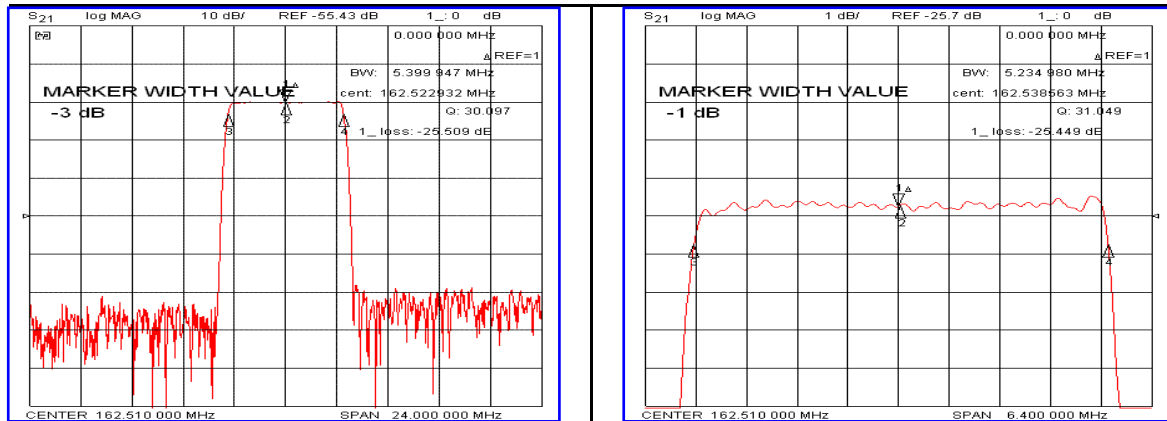

Specification

Parameter	Unit	Min.	Typ.	Max.
Center Frequency	MHz	-	162.51	-
Insertion Loss	dB	-	24.40	26.50
1dB Bandwidth	MHz	5.10	5.23	-
3dB Bandwidth	MHz	-	5.39	-
40dB Bandwidth	MHz	-	6.20	6.30
Passband Ripple($F_c \pm 2.46\text{MHz}$)	dB	-	0.55	1.20
Ultimate Attenuation	dB	40	45	-
Absolute Delay	μsec	-	2.55	-
Relative Attenuation $F_c \pm 2.46\text{M} \pm 0.5\text{MHz}$ Point	dB	-	20	-
Substrate Material	-	112-LiTaO ₃		
Temperature Coefficient	ppm/ $^{\circ}\text{C}$	-20		

Package Dimension

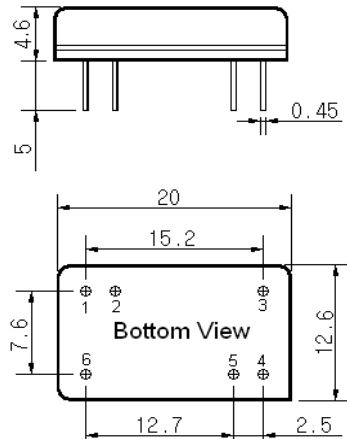

Matching Configuration

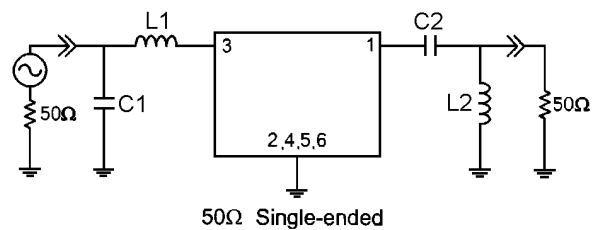

L1=2.7nH, L2=15nH, C1=100pF, C2=43pF
Source / Load Impedance = 50Ω
Ambient Temperature = 25°C

Rev 1. 120330

