

Typical Performance

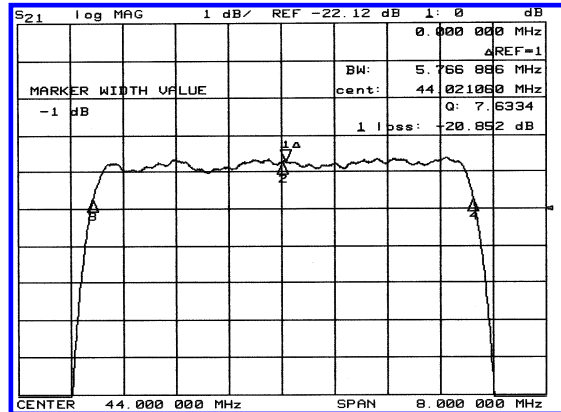
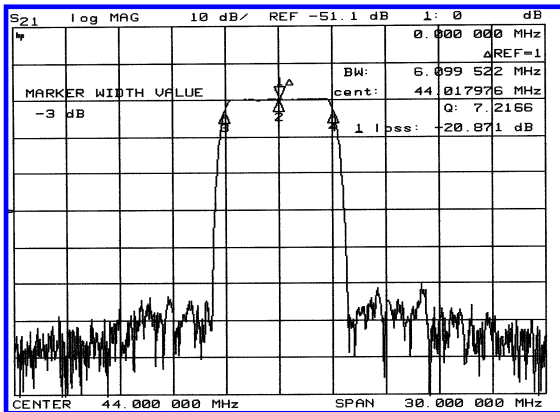

Specification

Parameter	Unit	Min.	Typ.	Max.
Center Frequency	Mhz	43.95	44.00	44.05
Insertion Loss	dB	-	20.5	22.0
1dB Bandwidth	Mhz	5.60	5.76	-
3dB Bandwidth	Mhz	5.90	6.00	-
40dB Bandwidth	Mhz	-	7.45	7.65
Passband Ripple	dB	-	0.45	1.00
Group Delay Variation	nsec	-	50	100
Absolute Delay	µsec	-	2.4	-
Ultimate Attenuation	dB	48	55	-
Substrate Material	-	128-LiNbO ₃		
Temperature Coefficient	ppm/°C	-72		

Package Dimension

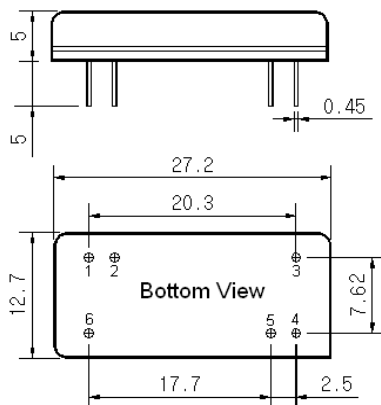

Matching Configuration

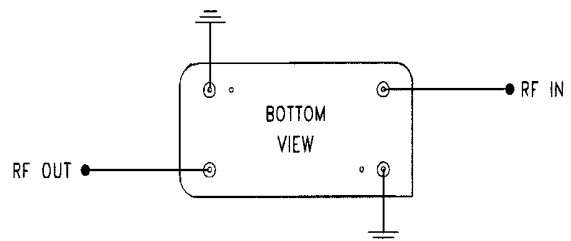

No Matching Required
 Source / Load Impedance = 50Ω
 Ambient Temperature = 25°C

12/30/2003