

### Typical Performance

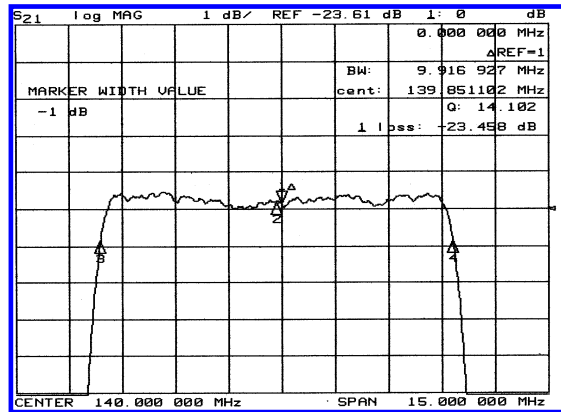
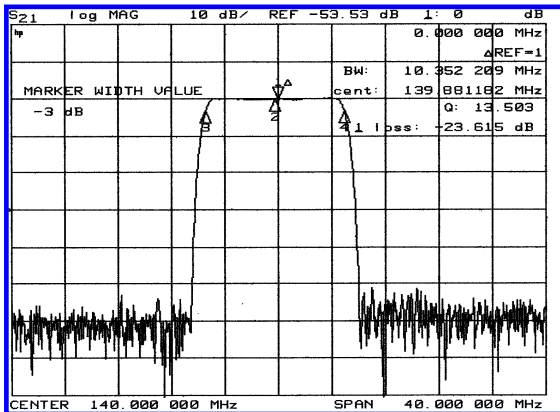

### Specification

Parameter	Unit	Min.	Typ.	Max.
Center Frequency	Mhz	139.85	140.00	140.15
Insertion Loss	dB	-	23.50	25.00
1dB Bandwidth	MHz	9.50	9.90	-
3dB Bandwidth	Mhz	10.00	10.35	-
40dB Bandwidth	Mhz	-	12.30	12.60
Passband Ripple	dB	-	0.45	0.80
Group Delay Variation	nsec	-	60	150
Absolute Delay	µsec	-	1.78	-
Ultimate Attenuation	dB	50	55	-
Substrate Material	-	YZ-LiNbO <sub>3</sub>		

### Package Dimension

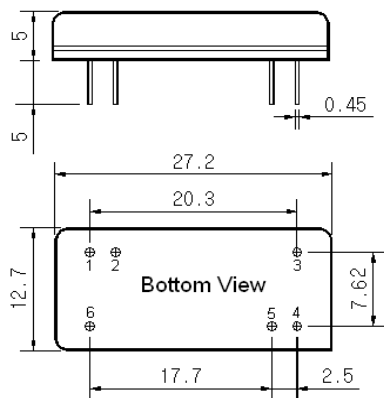

### Matching Configuration

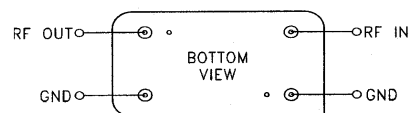

No Matching Required  
 Source / Load Impedance = 50Ω  
 Ambient Temperature = 25°C

05/15/2003