

Typical Performance

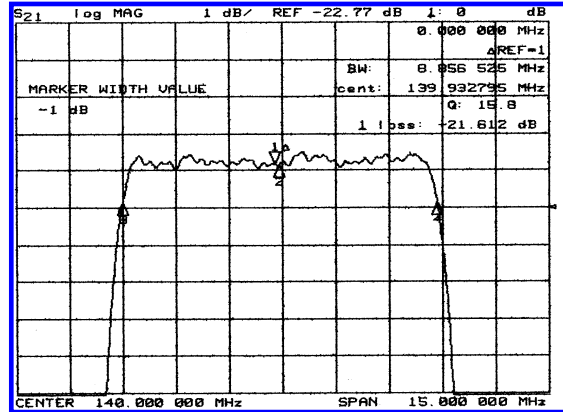
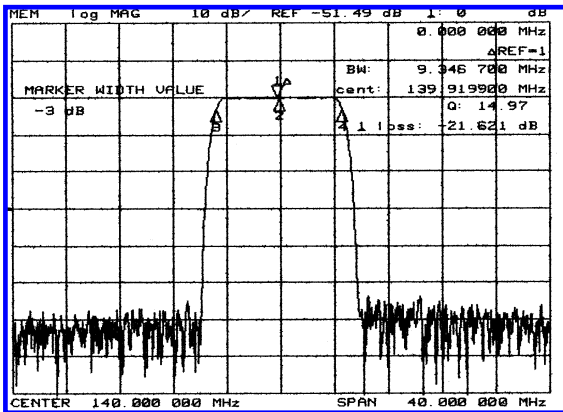

Specification

Parameter	Unit	Min.	Typ.	Max.
Center Frequency	Mhz	139.85	140.00	140.15
Insertion Loss	dB	-	21.50	23.50
1dB Bandwidth	MHz	8.50	8.85	-
3dB Bandwidth	Mhz	9.00	9.35	-
40dB Bandwidth	Mhz	-	11.35	11.70
Passband Ripple	dB	-	0.35	0.70
Group Delay Variation	nsec	-	70	210
Absolute Delay	µsec	-	1.74	-
Ultimate Attenuation	dB	50	55	-
Substrate Material	-	YZ- LiNbO ₃		

Package Dimension

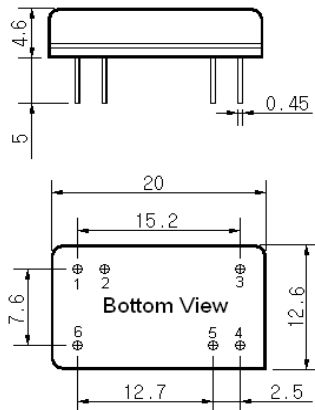

Matching Configuration

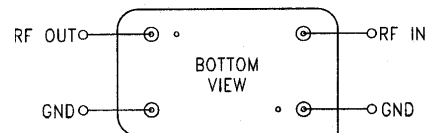

No Matching Required
Source / Load Impedance = 50Ω
Ambient Temperature = 25°C

06/17/2002