

Typical Performance

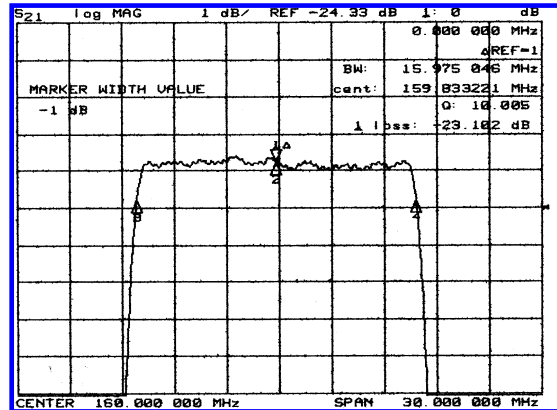
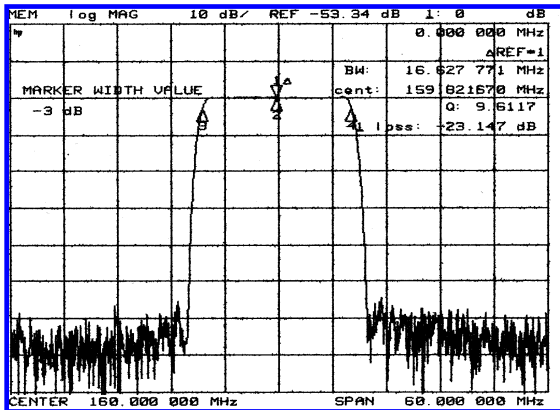

Specification

Parameter	Unit	Min.	Typ.	Max.
Center Frequency	Mhz	159.70	160.00	160.30
Insertion Loss	dB	-	23.50	25.50
1dB Bandwidth	MHz	15.60	15.98	-
3dB Bandwidth	Mhz	16.00	16.63	-
40dB Bandwidth	Mhz	-	19.42	19.70
Passband Ripple	dB	-	0.45	0.80
Group Delay Variation	nsec	-	80	100
Absolute Delay	µsec	-	1.43	-
Ultimate Attenuation	dB	55	60	-
Substrate Material	-	YZ- LiNbO ₃		

Package Dimension

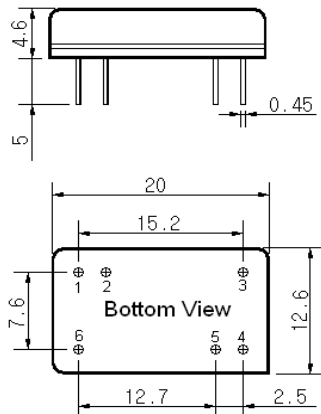

Matching Configuration

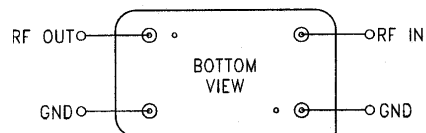

No Matching Required
 Source / Load Impedance = 50Ω
 Ambient Temperature = 25°C

06/21/2002