

Typical Performance

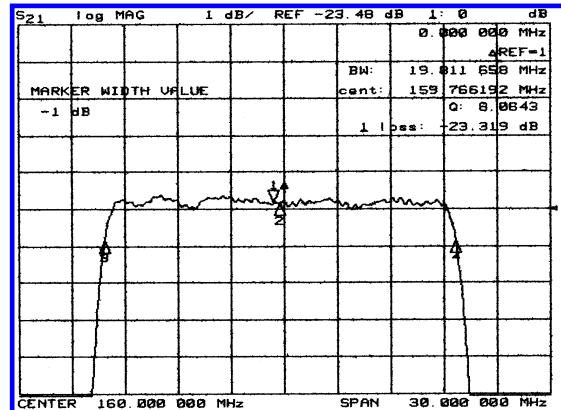
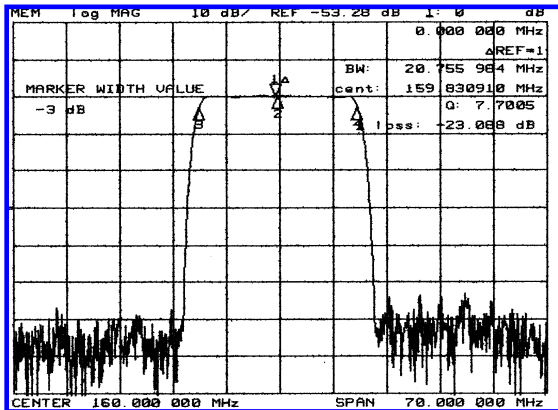

Specification

Parameter	Unit	Min.	Typ.	Max.
Center Frequency	Mhz	159.80	160.00	160.20
Insertion Loss	dB	-	23.50	25.50
1dB Bandwidth	MHz	19.50	19.80	-
3dB Bandwidth	Mhz	20.50	20.75	-
40dB Bandwidth	Mhz	-	24.42	25.00
Passband Ripple	dB	-	0.45	0.80
Group Delay Variation	nsec	-	60	100
Absolute Delay	µsec	-	1.17	-
Ultimate Attenuation	dB	55	60	-
Substrate Material	-	YZ- LiNbO ₃		

Package Dimension

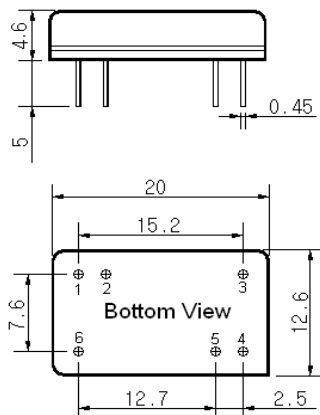

Matching Configuration

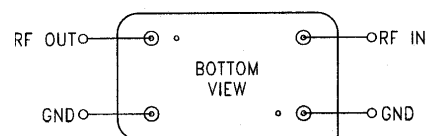

No Matching Required
Source / Load Impedance = 50Ω
Ambient Temperature = 25°C

11/28/2002