

Typical Performance

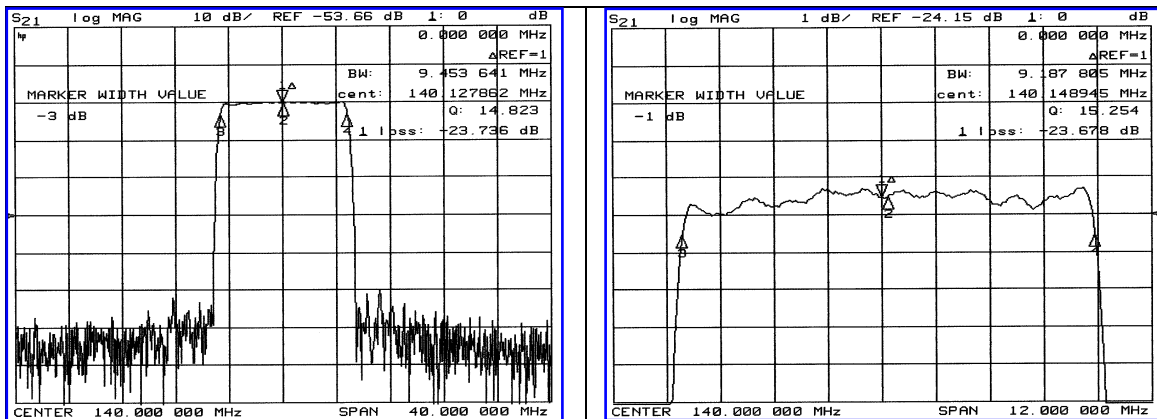

Specification

Parameter	Unit	Min.	Typ.	Max.
Center Frequency	MHz	139.85	140.00	140.15
Insertion Loss	dB	-	23.50	25.00
1dB Bandwidth	MHz	9.00	9.18	-
3dB Bandwidth	MHz	9.40	9.45	-
40dB Bandwidth	MHz	-	10.50	10.60
Passband Ripple	dB	-	0.75	1.00
Group Delay Variation	nsec	-	100	200
Absolute Delay	µsec	-	3.4	-
Ultimate Attenuation	dB	50	55	-
Substrate Material	-	LiTaO ₃		
Temperature Coefficient	ppm/°C	-20		

Package Dimension

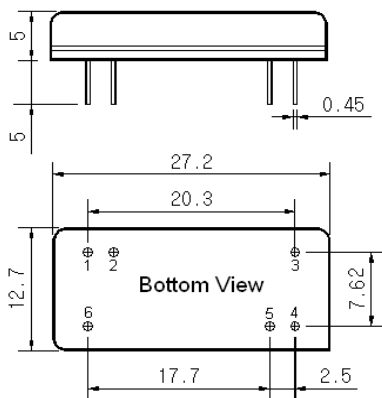

Matching Configuration

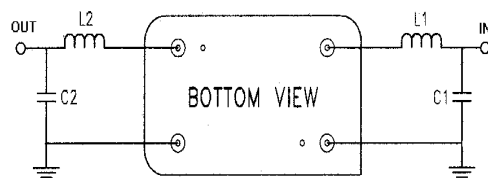

L1=33nH, L2=47nH, C1=36pF, C2=39pF
 Source / Load Impedance = 50Ω
 Ambient Temperature = 25°C

02/13/2004