

Typical Performance

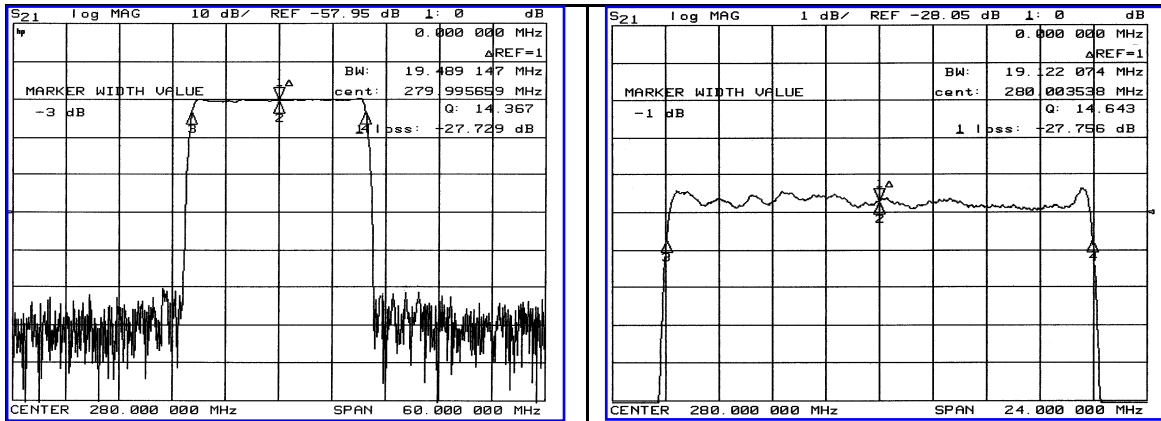

Specification

Parameter	Unit	Min.	Typ.	Max.
Center Frequency	MHz	279.85	280.00	280.15
Insertion Loss	dB	-	27.50	30.00
1dB Bandwidth	MHz	-	19.12	-
3dB Bandwidth	MHz	19.30	19.48	-
40dB Bandwidth	MHz	-	21.23	21.50
Passband Ripple	dB	-	0.70	1.00
Group Delay Variation	nsec	-	50	100
Absolute Delay	μsec	-	2.12	-
Ultimate Attenuation	dB	50	55	-
Operating Temp. Range	°C	-20	+25	+70
Substrate Material	-	LiTaO3		
Temperature Coefficient	ppm/°C	-20		

Package Dimension

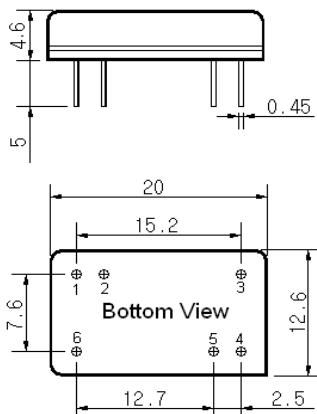

Matching Configuration

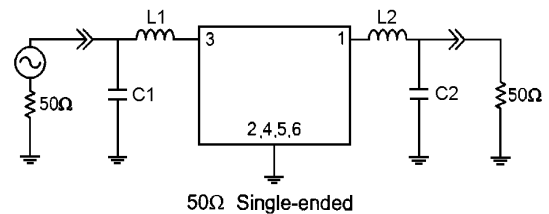

L1=10nH , L2=12nH, C1=30pF, C2=30pF
 Source / Load Impedance = 50Ω
 Ambient Temperature = 25°C

08/23/2005

