

Typical Performance

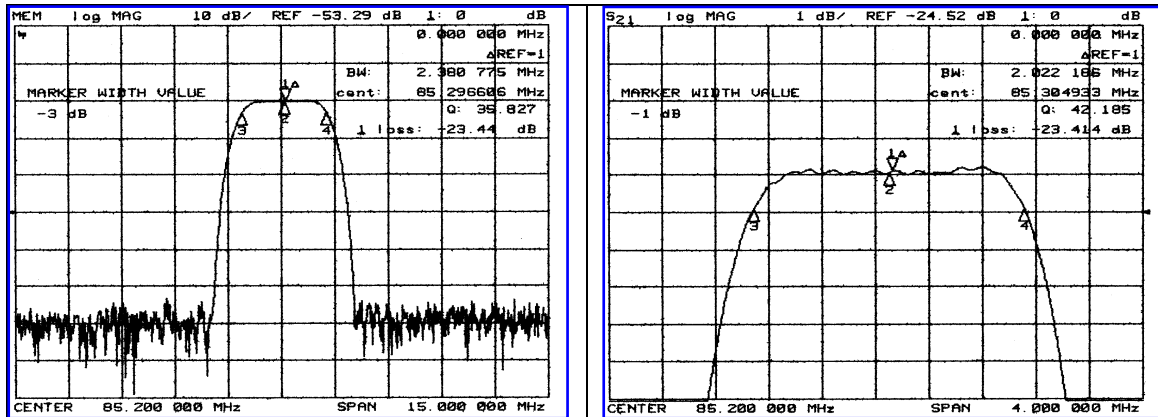

Specification

Parameter	Unit	Min.	Typ.	Max.
Center Frequency	Mhz	85.10	85.20	85.30
Insertion Loss	dB	-	23.50	25.00
1dB Bandwidth	MHz	1.70	2.02	-
3dB Bandwidth	Mhz	2.00	2.38	-
40dB Bandwidth	Mhz	-	3.76	4.00
Passband Ripple	dB	-	0.45	0.80
Group Delay Variation	nsec	-	150	200
Absolute Delay	µsec	-	3.15	-
Ultimate Attenuation	dB	50	55	-
Substrate Material	-	LiTaO ₃		

Package Dimension

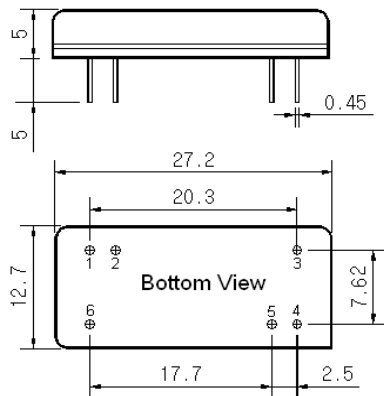

Matching Configuration

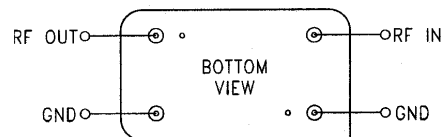

No Matching Required
Source / Load Impedance = 50Ω
Ambient Temperature = 25°C

09/05/2002