

### Typical Performance

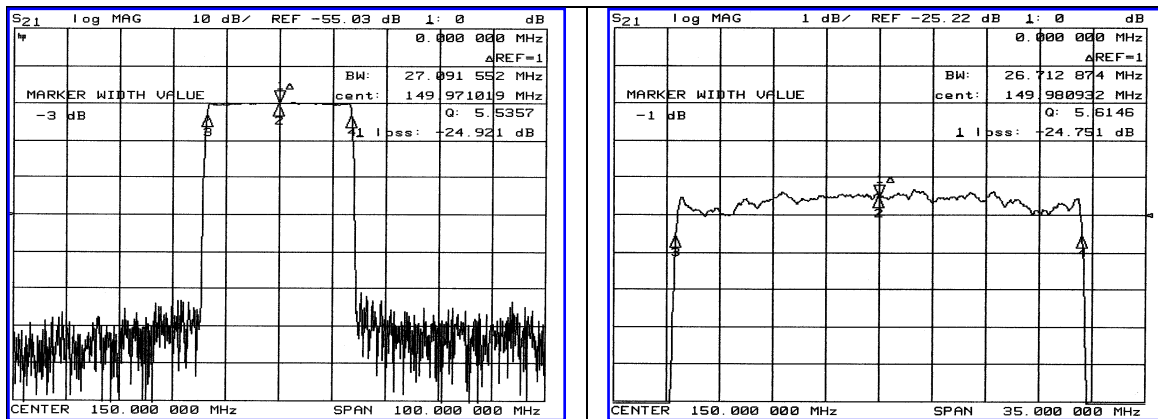

### Specification

Parameter	Unit	Min.	Typ.	Max.
Center Frequency	MHz	149.80	150.00	150.20
Insertion Loss	dB	-	25.00	26.50
1dB Bandwidth	MHz	-	26.71	-
3dB Bandwidth	MHz	26.90	27.09	-
40dB Bandwidth	MHz	-	28.76	28.90
Passband Ripple	dB	-	0.65	1.00
Group Delay Variation	nsec	-	50	100
Absolute Delay	µsec	-	1.91	-
Ultimate Attenuation	dB	50	55	-
Substrate Material	-	128-LiNbO <sub>3</sub>		
Temperature Coefficient	ppm/°C	-72		

### Package Dimension

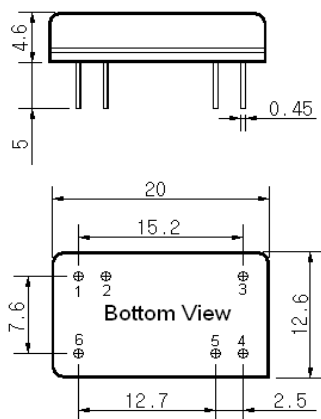

### Matching Configuration

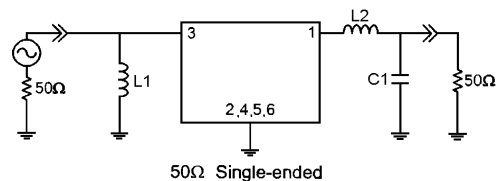

L1=82nH, L2=47nH, C1=24pF  
 Source / Load Impedance = 50Ω  
 Ambient Temperature = 25°C

09/29/2005

