

Typical Performance

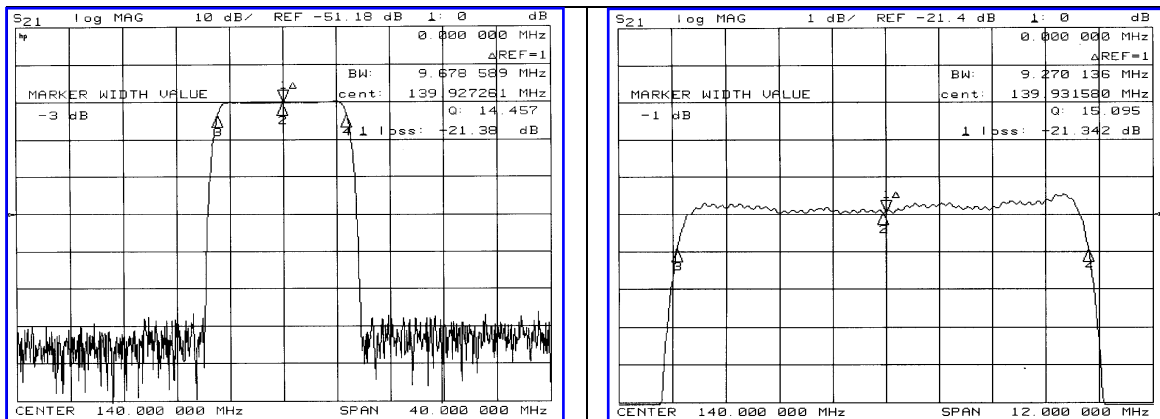

Specification

Parameter	Unit	Min.	Typ.	Max.
Center Frequency	MHz	139.85	140.00	140.15
Insertion Loss	dB	-	22.00	24.00
1dB Bandwidth	MHz	-	9.27	-
3dB Bandwidth	MHz	9.50	9.67	-
40dB Bandwidth	MHz	-	11.39	11.60
Passband Ripple	dB	-	0.55	1.00
Group Delay Variation	nsec	-	50	100
Absolute Delay	µsec	-	2.52	-
Ultimate Attenuation	dB	50	55	-
Substrate Material	-	LiTaO ₃		
Temperature Coefficient	ppm/°C	-20		

Package Dimension

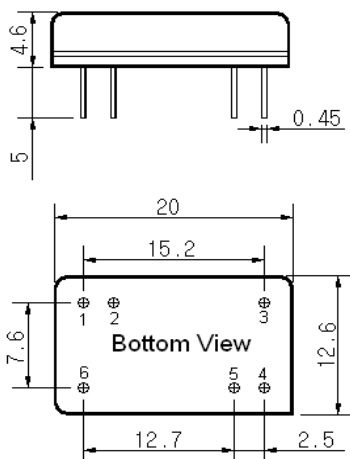

Matching Configuration

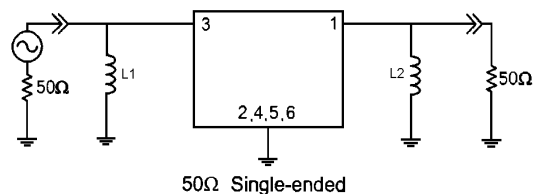

L1=27nH, L2=33nH
 Source / Load Impedance = 50Ω
 Ambient Temperature = 25°C

05/17/2006

