

Typical Performance

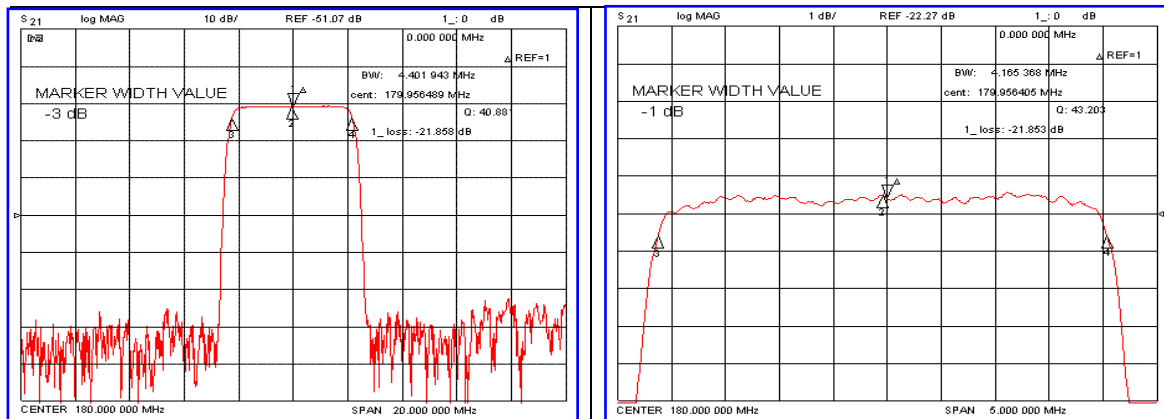

Specification

Parameter	Unit	Min.	Typ.	Max.
Center Frequency	MHz	179.85	180.00	180.15
Insertion Loss	dB	-	21.90	24.00
1dB Bandwidth	MHz	-	4.16	-
3dB Bandwidth	MHz	4.20	4.40	-
40dB Bandwidth	MHz	-	5.20	5.50
Passband Ripple	dB	-	0.65	1.00
Group Delay Variation	nsec	-	100	200
Absolute Delay	μsec	-	3.02	-
Ultimate Attenuation	dB	50	53	-
Substrate Material	-	Quartz		
Temperature Coefficient	ppm/°C ²	-0.03		

Package Dimension

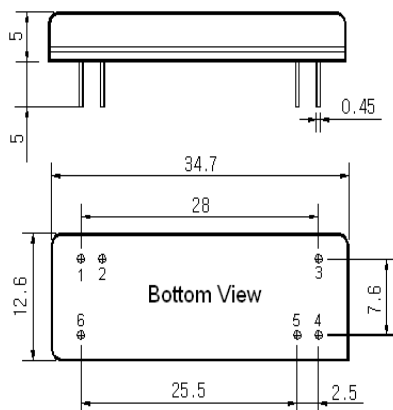

Matching Configuration

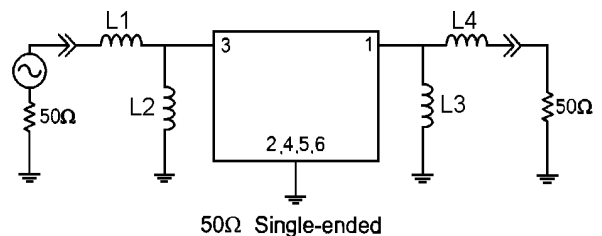

L1=L4=56nH, L2=27nH, L3=39nH
 Source / Load Impedance = 50Ω
 Ambient Temperature = 25°C

10/01/2006

