

Typical Performance

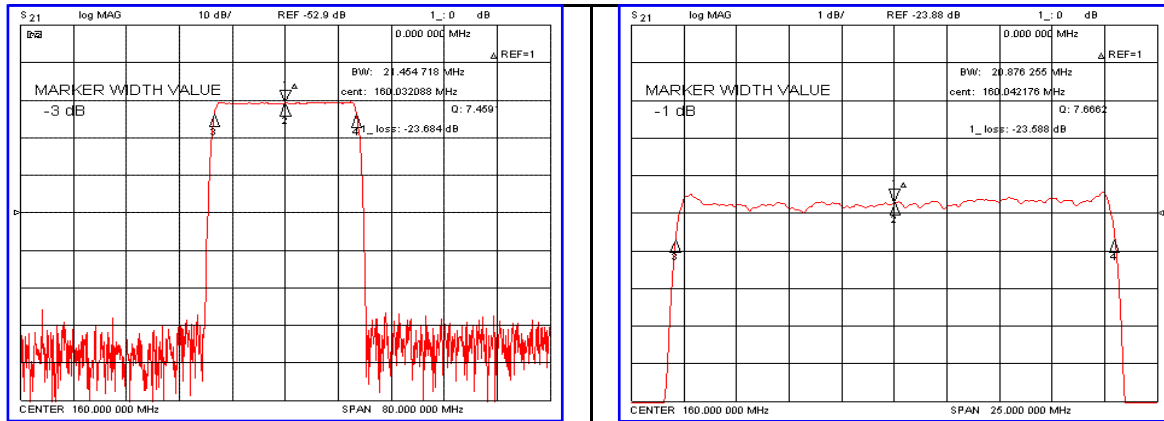

Specification

Parameter	Unit	Min.	Typ.	Max.
Center Frequency (Fc)	MHz	-	160.00	-
Insertion Loss	dB	-	23.80	25.50
1dB Bandwidth	MHz	-	20.95	-
3dB Bandwidth	MHz	21.00	21.45	-
40dB Bandwidth	MHz	-	23.86	24.00
Passband Ripple (Fc±9.22MHz)	dB	-	0.55	1.00
Group Delay Variation (Fc±9.22MHz)	nsec	-	28	50
Absolute Delay	µsec	-	1.35	-
Ultimate Attenuation	dB	50	55	-
Substrate Material	-	128-LiNbO ₃		
Temperature Coefficient	ppm/°C	-72		

Package Dimension

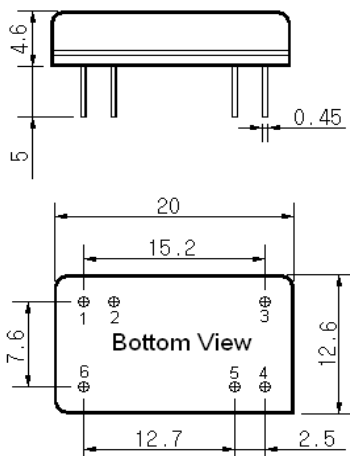

Matching Configuration

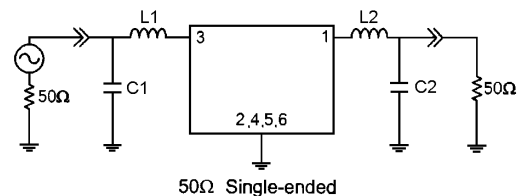

L1 = 5.6nH, L2 = 6.8nH, C1 = C2 = 12pF
 Source / Load Impedance = 50Ω
 Ambient Temperature = 25°C

Rev1.061215

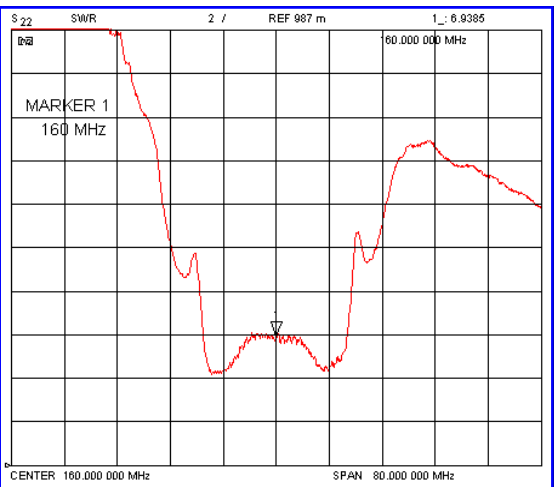
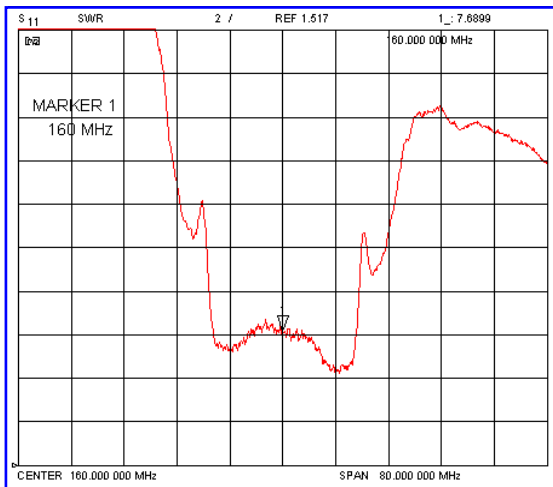
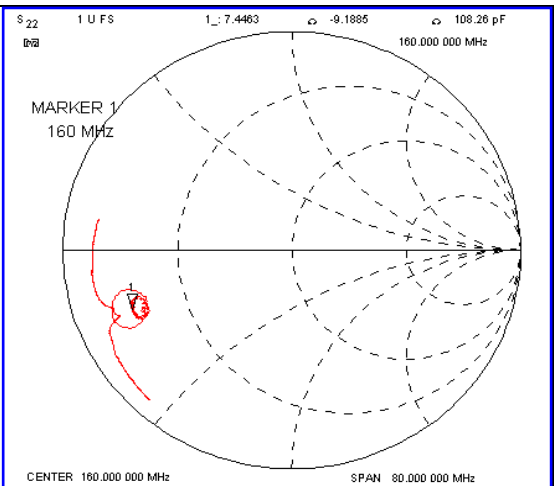
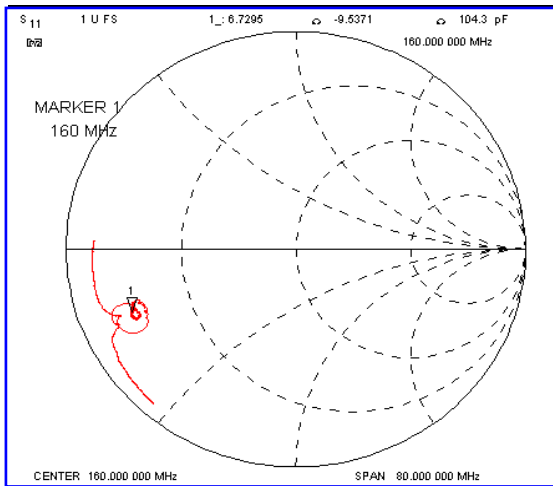
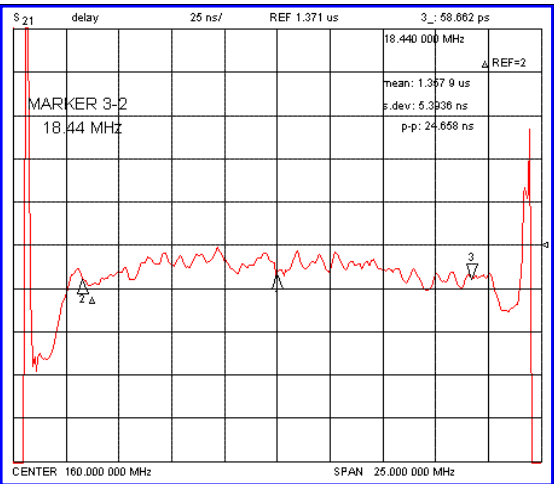
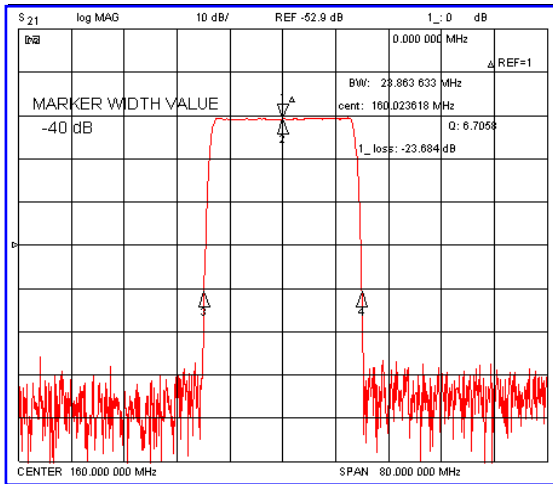

Group Delay Variation 1FA

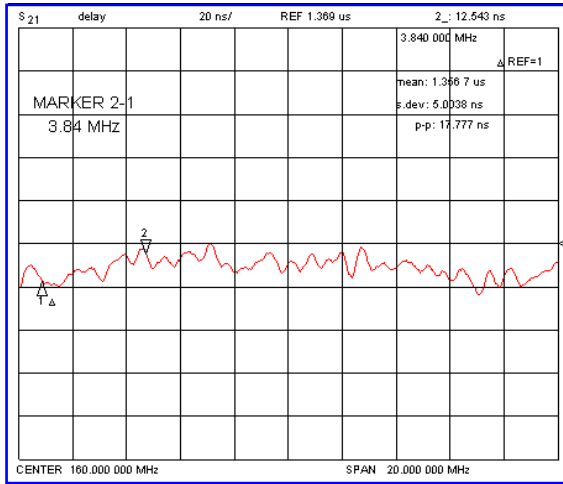

Group Delay Variation 2FA

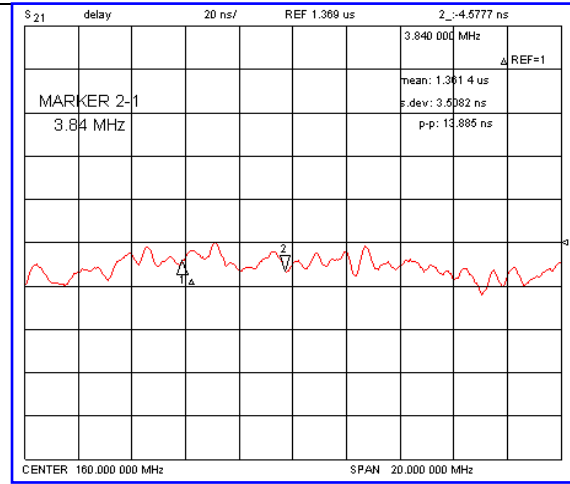

Group Delay Variation 3FA

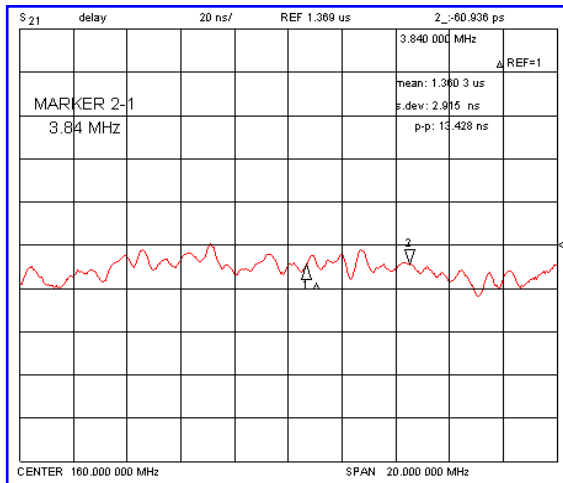

Group Delay Variation 4FA

