

Typical Performance

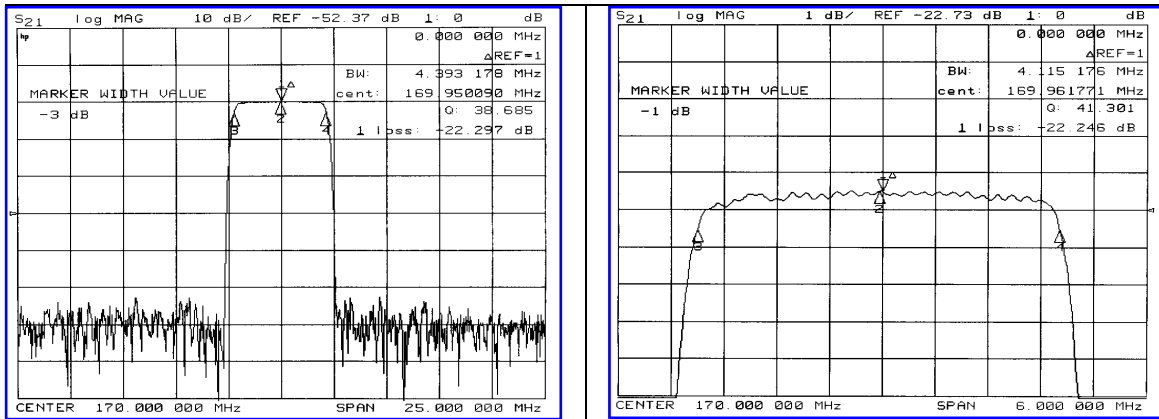

Specification

Parameter	Unit	Min.	Typ.	Max.
Center Frequency	MHz	169.85	170.00	170.15
Insertion Loss	dB	-	22.50	24.00
1dB Bandwidth	MHz	-	4.11	-
3dB Bandwidth	MHz	4.20	4.39	-
40dB Bandwidth	MHz	-	5.19	5.50
Passband Ripple	dB	-	0.55	1.00
Group Delay Variation	nsec	-	100	200
Absolute Delay	µsec	-	3.00	-
Ultimate Attenuation	dB	50	53	-
Substrate Material	-	Quartz		
Temperature Coefficient	ppm/°C ²	-0.03		

Package Dimension

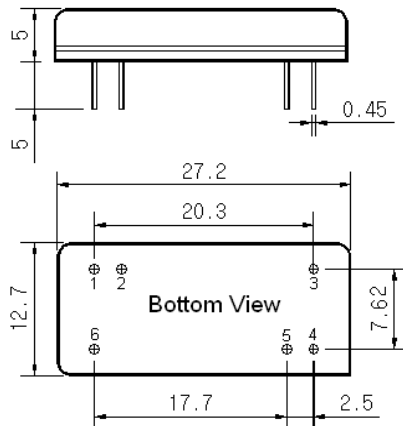

Matching Configuration

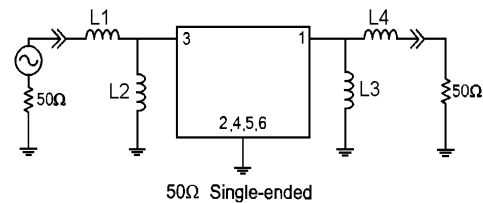

L1=68nH, L2=33nH, L3=39nH, L4=82nH
 Source / Load Impedance = 50Ω
 Ambient Temperature = 25°C

02/28/2006

