

Typical Performance

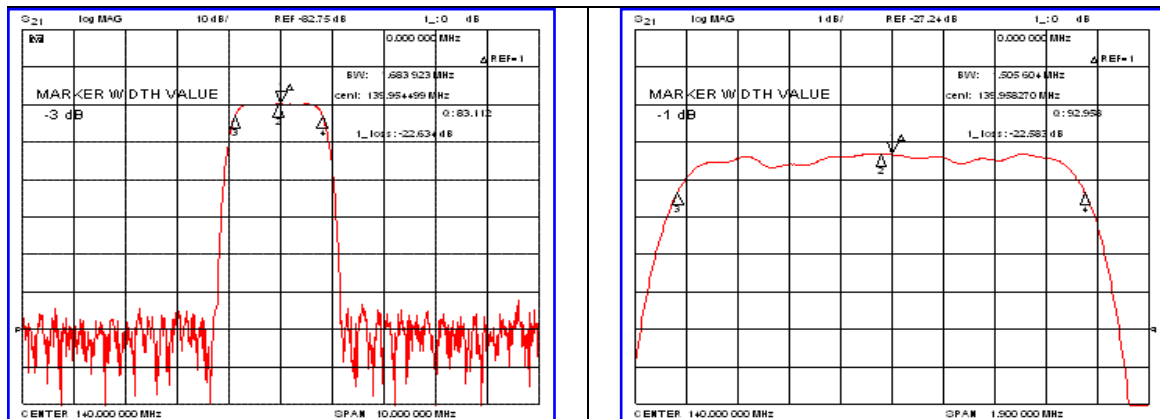

Specification

Parameter	Unit	Min.	Typ.	Max.
Center Frequency	MHz	139.85	140.00	139.15
Insertion Loss	dB	-	22.70	25.00
1dB Bandwidth	MHz	-	1.50	-
3dB Bandwidth	MHz	1.60	1.68	-
50dB Bandwidth	MHz	-	2.35	2.50
Passband Ripple	dB	-	0.50	1.00
Group Delay Variation	nsec	-	150	250
Absolute Delay	µsec	-	3.52	-
Ultimate Attenuation	dB	50	55	-
Substrate Material	-	Quartz		
Temperature Coefficient	ppm/°C	-0.03		

Package Dimension

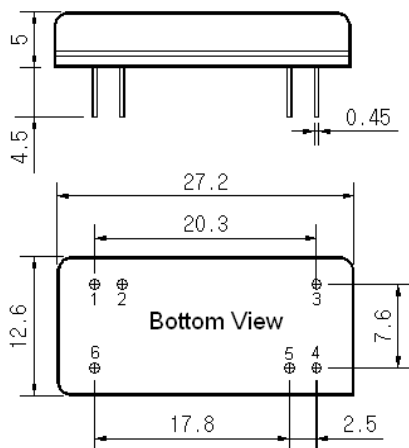

Matching Configuration

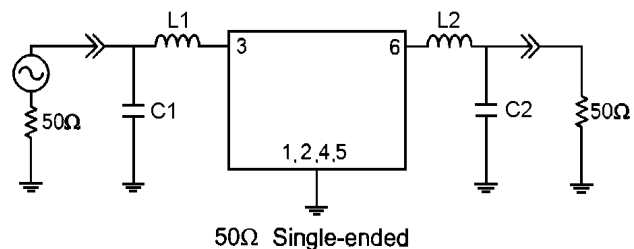

L1=33nH, L2=27nH, C1=47pF, C2=47pF
 Source / Load Impedance = 50Ω
 Ambient Temperature = 25°C

Rev.0 081007

