

### Typical Performance

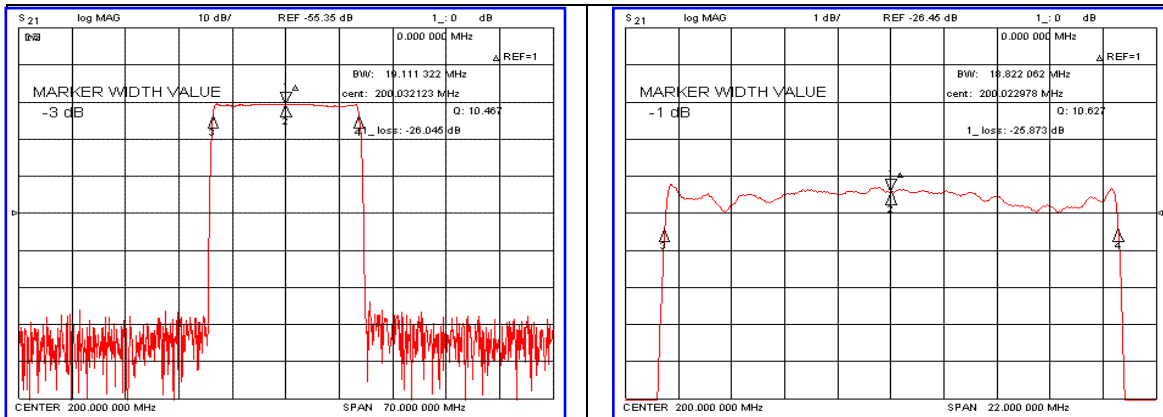

### Specification

Parameter	Unit	Min.	Typ.	Max.
Center Frequency	MHz	199.80	200.00	200.20
Insertion Loss	dB	-	26.50	28.00
1dB Bandwidth	MHz	-	18.82	-
3dB Bandwidth	MHz	19.00	19.11	-
40dB Bandwidth	MHz	-	20.37	-
50dB Bandwidth	MHz	-	20.51	20.70
Passband Ripple	dB	-	0.50	1.00
Group Delay Variation	nsec	-	70	150
Absolute Delay	μsec	-	3.03	-
Ultimate Attenuation	dB	50	55	-
Substrate Material	-	112-LiTaO <sub>3</sub>		
Temperature Coefficient	ppm/°C	-20		

### Package Dimension

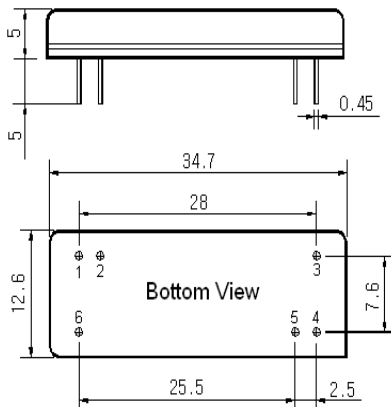

### Matching Configuration

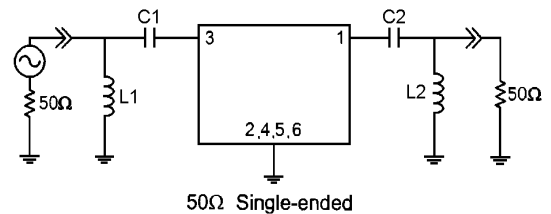

L1=15nH, L2=15nH, C1=68pF, C2=68pF  
 Source / Load Impedance = 50Ω  
 Ambient Temperature = 25°C

Rev0. 070118

