

### Typical Performance

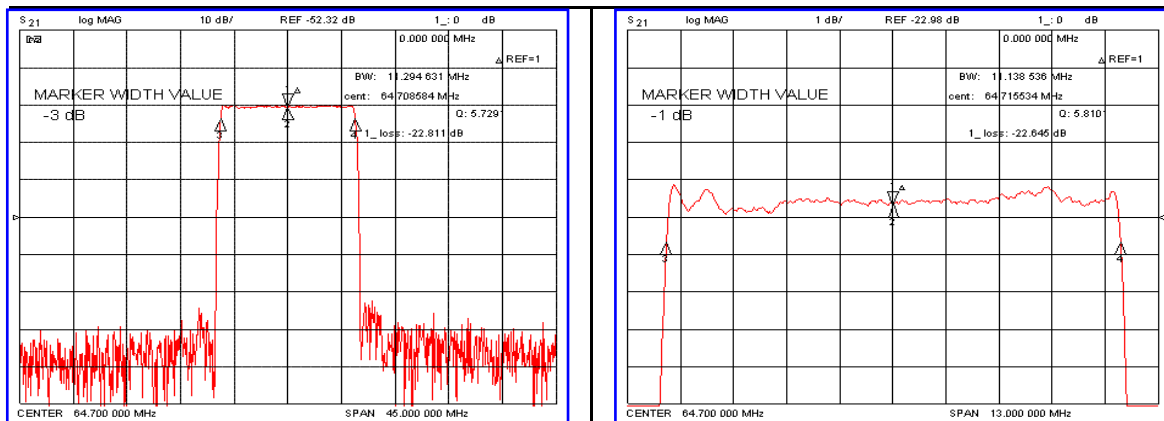

### Specification

Parameter	Unit	Min.	Typ.	Max.
Center Frequency (Fc)	MHz	64.62	64.70	64.78
Insertion Loss	dB	-	23.50	25.00
1dB Bandwidth	MHz	11.00	11.13	-
3dB Bandwidth	MHz	-	11.29	-
15dB Bandwidth	MHz	-	11.70	11.80
40dB Bandwidth	MHz	-	12.01	12.20
Passband Ripple	dB	-	0.75	1.00
Group Delay Variation	nsec	-	100	200
Absolute Delay	μsec	-	3.89	-
Ultimate Attenuation	dB	50	55	-
Substrate Material	-	128-LiNbO <sub>3</sub>		
Temperature Coefficient	ppm/°C	-72		

### Package Dimension

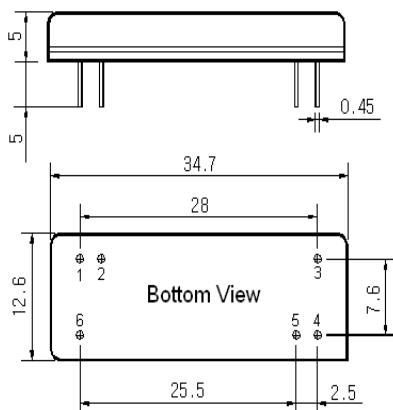

### Matching Configuration

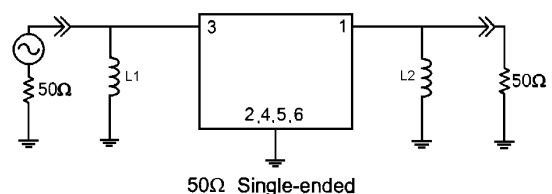

L1= 180nH, L2=220nH  
 Source / Load Impedance = 50Ω  
 Ambient Temperature = 25°C

Rev0.061211

