

Typical Performance

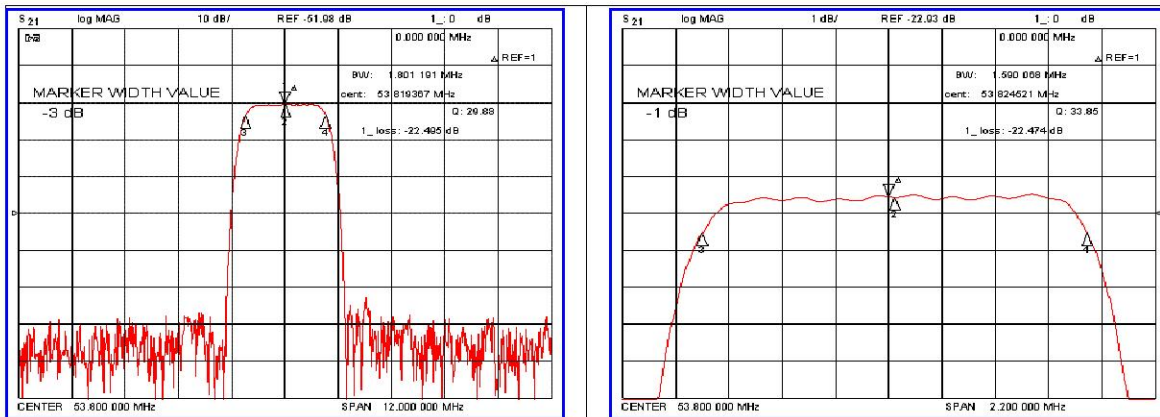

Specification

Parameter	Unit	Min.	Typ.	Max.
Center Frequency	MHz	53.72	53.80	53.88
Insertion Loss	dB	-	23.00	25.00
1dB Bandwidth	MHz	-	1.59	-
3dB Bandwidth	MHz	1.70	1.80	-
40dB Bandwidth	MHz	-	2.58	2.80
Passband Ripple	dB	-	0.55	1.00
Group Delay Variation	nsec	-	100	200
Absolute Delay	µsec	-	3.20	-
Ultimate Attenuation	dB	48	53	
Substrate Material	-	Quartz		
Temperature Coefficient	ppm/°C	-0.03		

Package Dimension

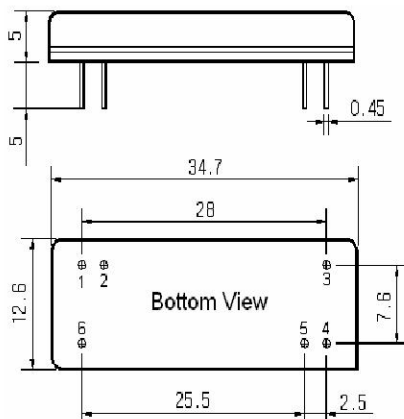

Matching Configuration

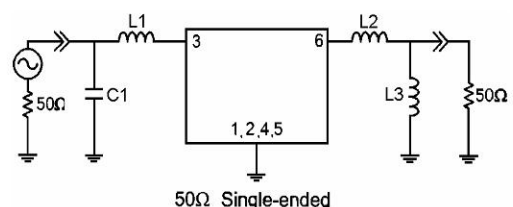

L1=470nH, L2=270nH, L3=82nH, C1=91pF
 Source / Load Impedance = 50Ω
 Ambient Temperature = 25°C

Rev0.061220

