

Typical Performance

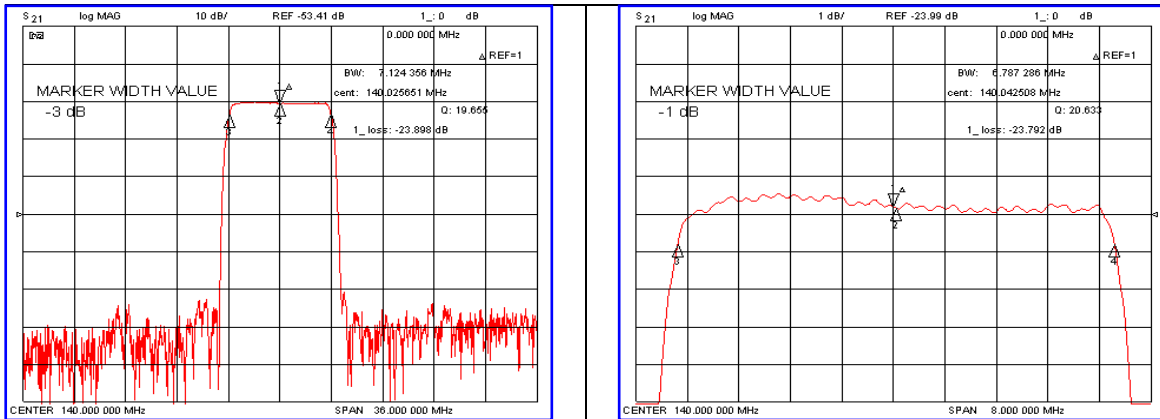

Specification

Parameter	Unit	Min.	Typ.	Max.
Center Frequency	MHz	139.85	140.00	140.15
Insertion Loss	dB	-	23.89	25.50
1dB Bandwidth	MHz	6.50	6.78	-
3dB Bandwidth	MHz	-	7.12	-
40dB Bandwidth	MHz	-	8.35	8.50
Passband Ripple	dB	-	0.55	1.00
Group Delay Variation	nsec	-	110	200
Absolute Delay	µsec	-	2.04	-
Ultimate Attenuation	dB	47	51	-
Substrate Material	-	112-LiTaO ₃		
Temperature Coefficient	ppm/°C	-20		

Package Dimension

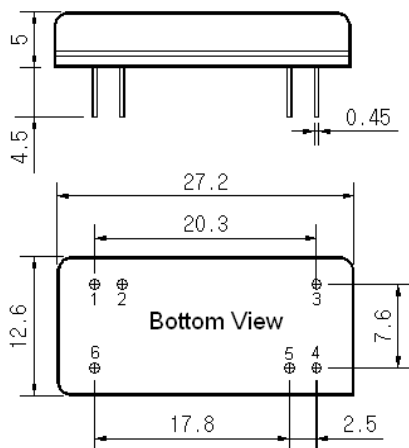

Matching Configuration

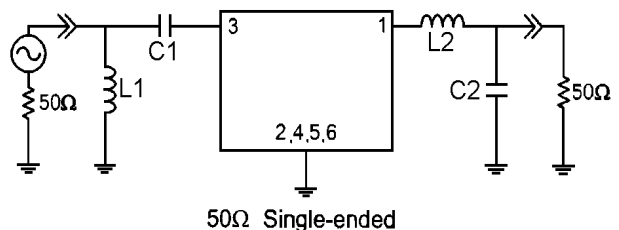

L1=12nH, L2=12nH, C1=68pF, C2=56pF
 Source / Load Impedance = 50Ω
 Ambient Temperature = 25°C

Rev.1 100621

