

Typical Performance

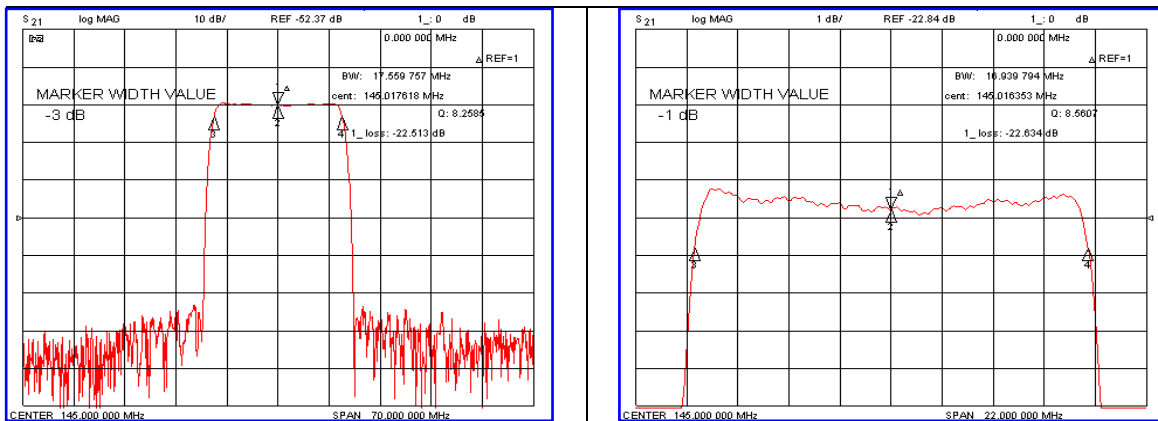

Specification

Parameter	Unit	Min.	Typ.	Max.
Center Frequency	MHz	-	145.00	-
Insertion Loss	dB	-	22.51	25.00
1dB Bandwidth	MHz	16.70	16.93	-
3dB Bandwidth	MHz	-	17.55	-
40dB Bandwidth	MHz	-	20.30	20.60
Passband Ripple($F_c \pm 7.56$ MHz)	dB	-	0.70	1.00
Group Delay Variation($F_c \pm 7.56$ MHz)	nsec	-	30	50
Absolute Delay	μ sec	-	1.24	-
Ultimate Attenuation	dB	50	55	-
Substrate Material	-	128- LiNbO ₃		
Temperature Coefficient	ppm/ $^{\circ}$ C	-72		

Package Dimension

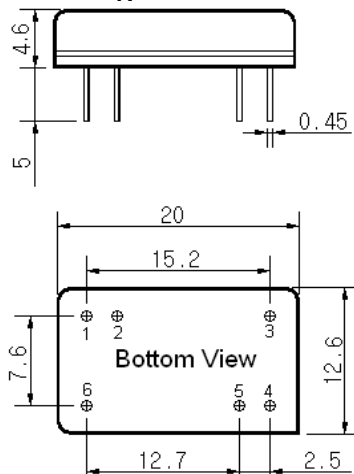

Matching Configuration

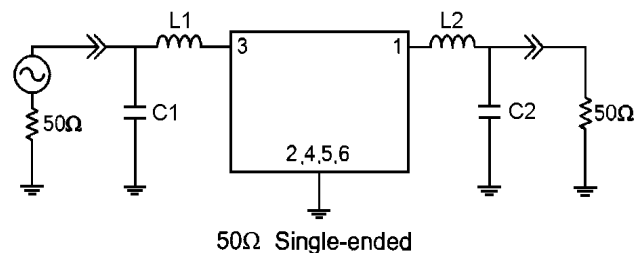

L1=8.2nH, L2=10nH, C1=6pF, C2=6pF
 Source / Load Impedance = 50 Ω
 Ambient Temperature = 25 $^{\circ}$ C

Rev0. 090525

