

Typical Performance

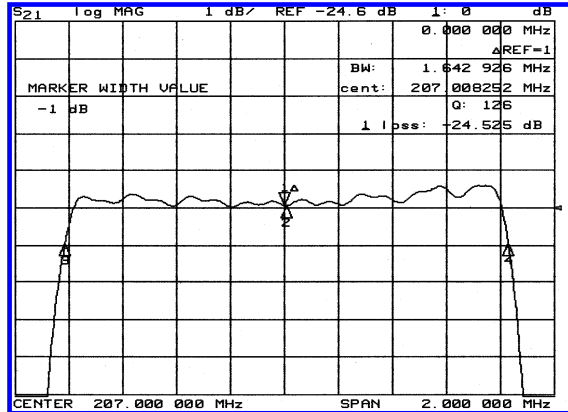
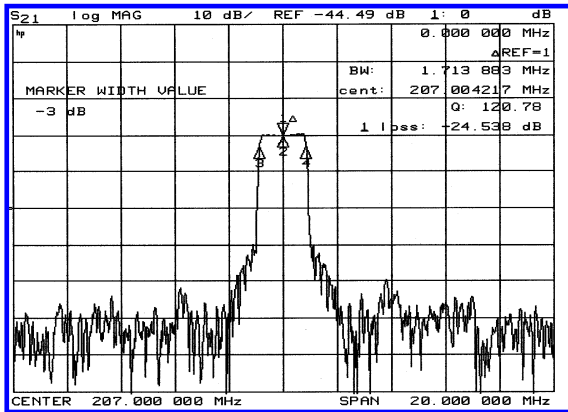

Specification

Parameter	Unit	Min.	Typ.	Max.
Center Frequency	Mhz	206.958	207.008	207.058
Insertion Loss	dB	-	24.50	-
1dB Bandwidth	Mhz	1.55	1.64	-
3dB Bandwidth	Mhz	1.65	1.71	-
30dB Bandwidth	Mhz	-	2.03	2.10
50dB Bandwidth	Mhz	-	-	-
Passband Ripple	dB	-	0.55	1.00
Group Delay Variation	nsec	-	100	200
Absolute Delay	µsec	-	4.8	-
Ultimate Attenuation	dB	-	40	-
Substrate Material	-	Quartz		
Temperature Coefficient	ppm/°C <sup>2</sup>	-0.03		

Package Dimension

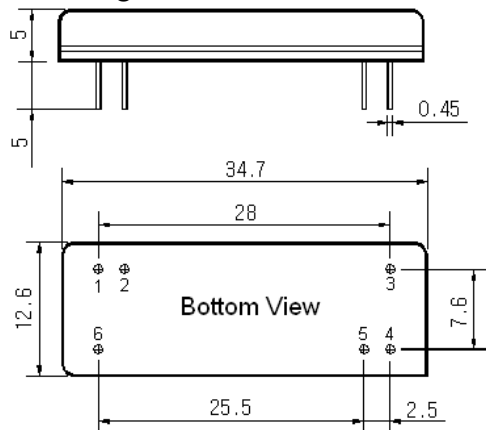

Matching Configuration

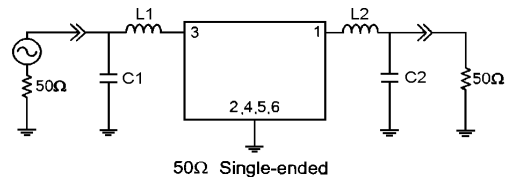

L1=10nH, L2=8.2nH, C1=33pF, C2=68pF  
Source / Load Impedance = 50Ω  
Ambient Temperature = 25°C

01/14/2005

