

Typical Performance

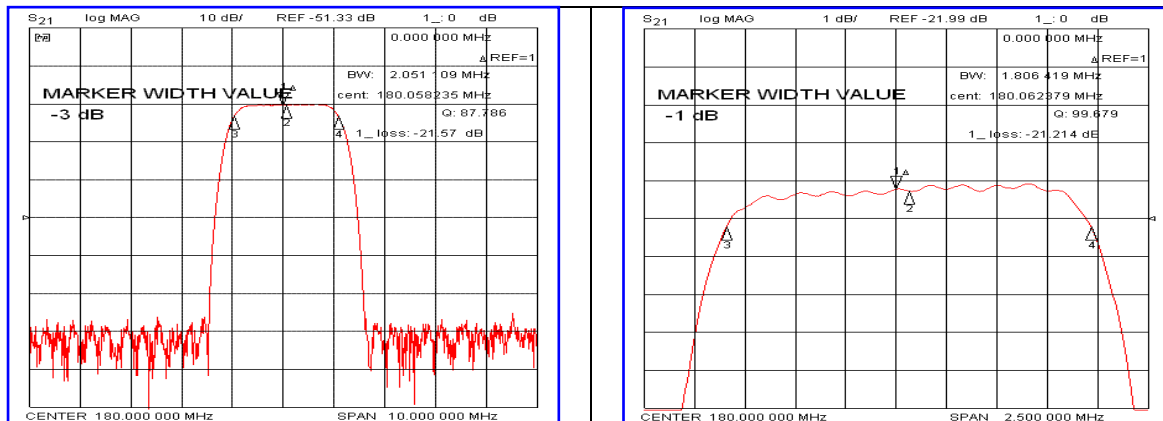

Specification

Parameter	Unit	Min.	Typ.	Max.
Center Frequency	MHz	179.90	180.00	180.10
Insertion Loss	dB	-	21.60	24.00
1dB Bandwidth	MHz	1.74	1.80	-
3dB Bandwidth	MHz	-	2.05	-
40dB Bandwidth	MHz	-	2.93	3.10
Passband Ripple	dB	-	0.55	1.00
Group Delay Variation	nsec	-	200	300
Absolute Delay	usec	-	3.10	-
Ultimate Attenuation	dB	50	55	-
Substrate Material	-	Quartz		
Temperature Coefficient	ppm/°C	-0.03		

Package Dimension

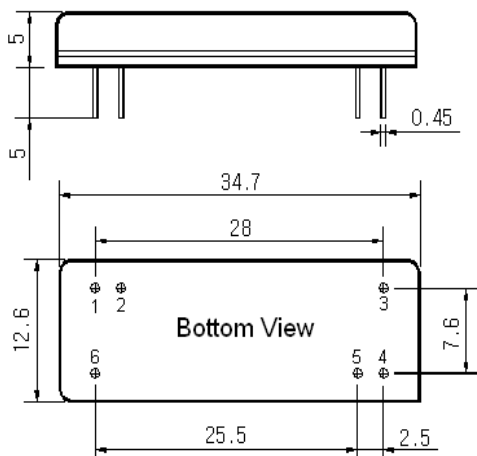

Matching Configuration

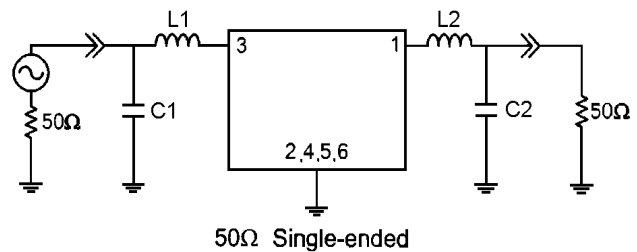

L1=15nH, L2=10nH, C1=43pF, C2=47pF
 Source / Load Impedance = 50Ω
 Ambient Temperature = 25°C

Rev.0 100723

