

Typical Performance

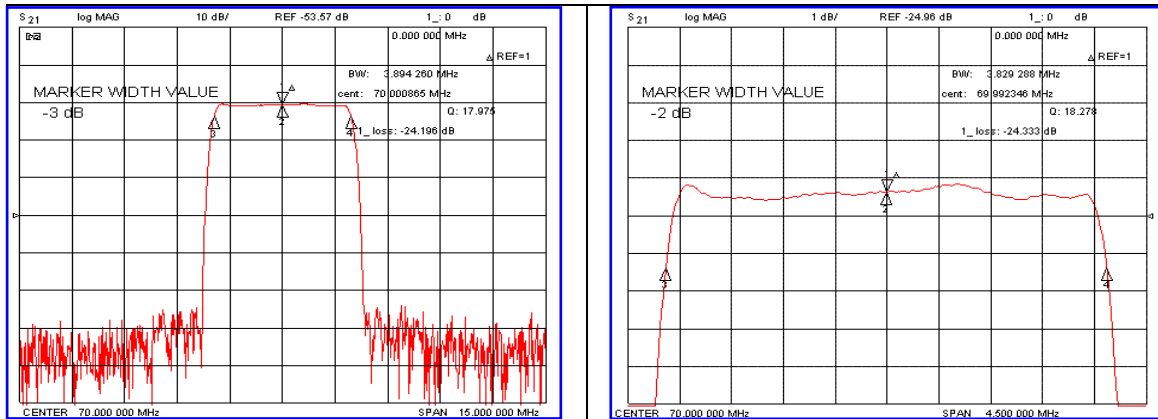

Specification

Parameter	Unit	Min.	Typ.	Max.
Center Frequency	MHz	69.92	70.00	70.08
Insertion Loss	dB	-	24.50	26.00
2dB Bandwidth	MHz	3.75	3.82	-
25dB Bandwidth	MHz	-	4.39	4.50
40dB Bandwidth	MHz	-	4.52	4.60
Passband Ripple	dB	-	0.50	1.00
Group Delay Variation	nsec	-	75	150
Absolute Delay	μsec	-	5.28	-
Ultimate Attenuation	dB	50	55	-
Substrate Material	-	112-LiTaO ₃		
Temperature Coefficient	ppm/°C	-20		

Package Dimension

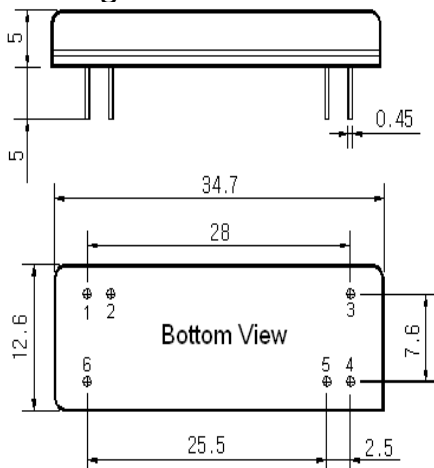

Matching Configuration

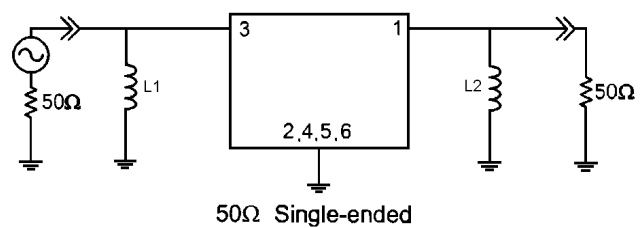

L1=68nH, L2=82nH
 Source / Load Impedance = 50Ω
 Ambient Temperature = 25°C

Rev1. 090629

