

## Typical Performance

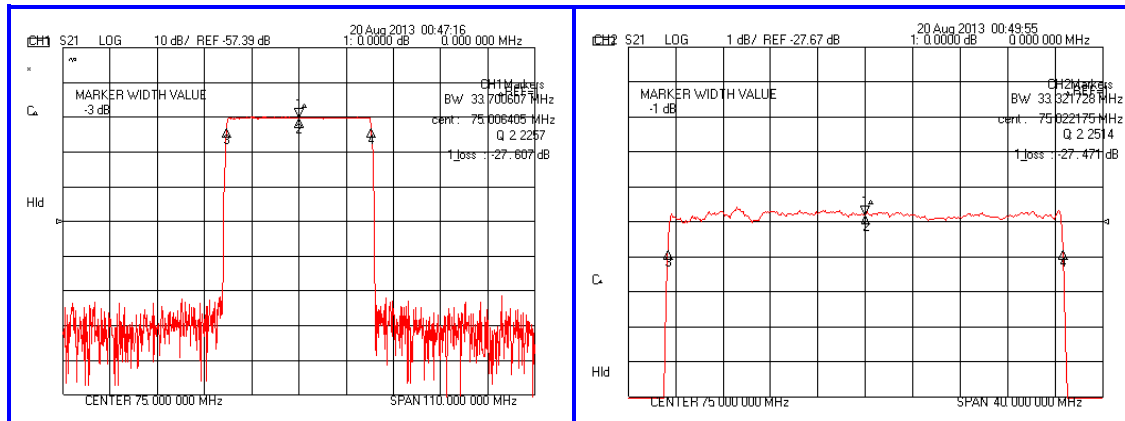

## Specification

Parameter	Unit	Min.	Typ.	Max.
Center Frequency	MHz	-	75.00	-
Insertion Loss	dB	-	27.50	29.50
1dB Bandwidth	MHz	33.10	33.32	-
3dB Bandwidth	MHz	-	33.70	-
40dB Bandwidth	MHz	-	35.23	35.40
Attenuation	dB	45	50	-
Amplitude Ripple ( $F_c \pm 16\text{MHz}$ )	dB	-	0.50	1.20
Group Delay Variation ( $F_c \pm 16\text{MHz}$ )	nsec	-	20	80
Absolute Delay	$\mu\text{sec}$	-	2.09	-
Substrate Material & T.C.F	ppm/ $^{\circ}\text{C}$	128-LiNbO <sub>3</sub> & -72		
Package	mm	20 X 12 (DIP)		

## Package Dimension

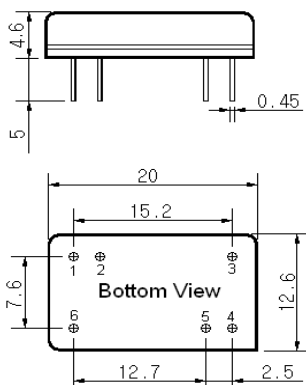

## Matching Configuration

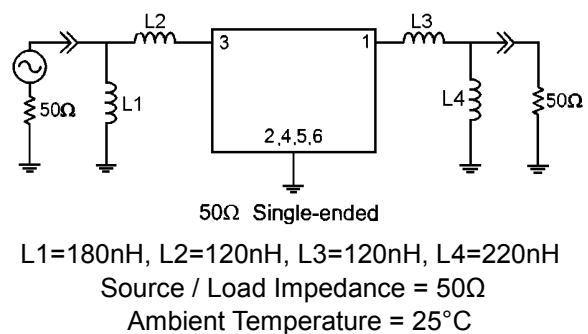

Rev0.130823

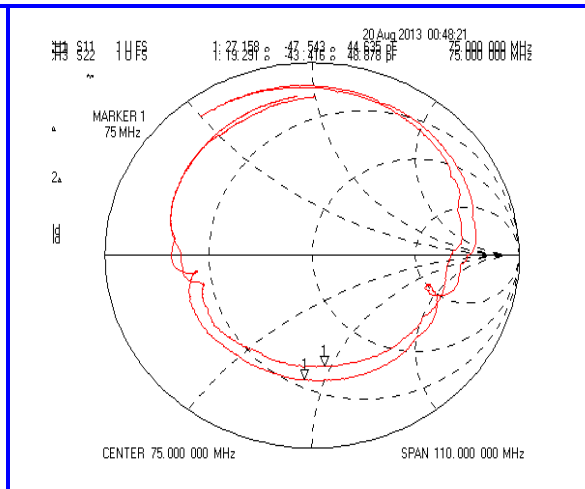
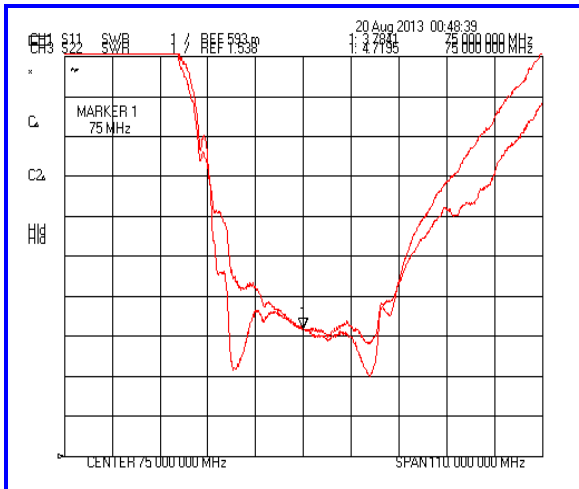
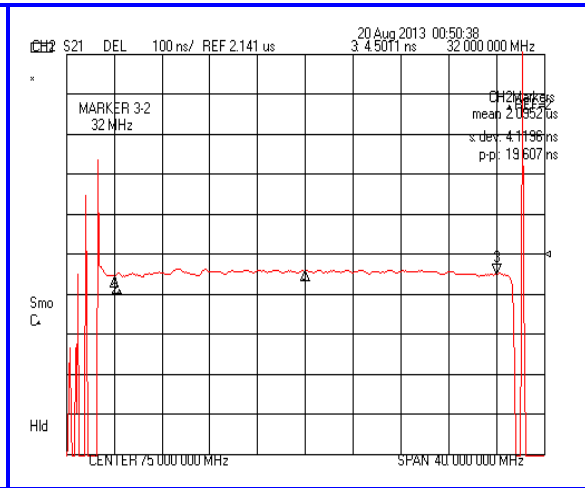
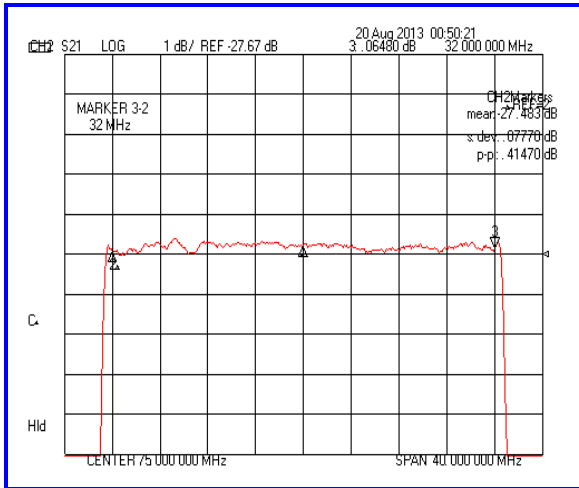
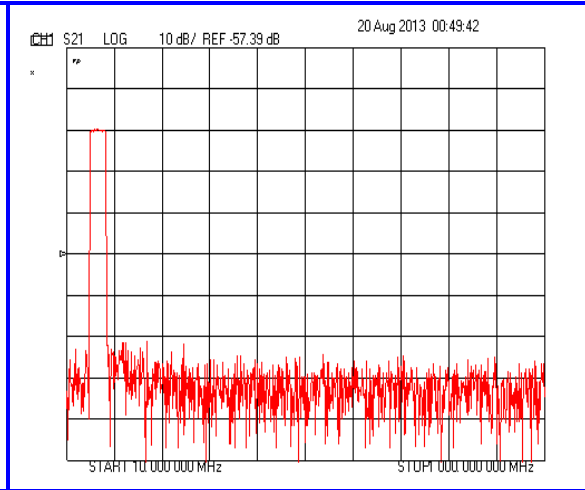
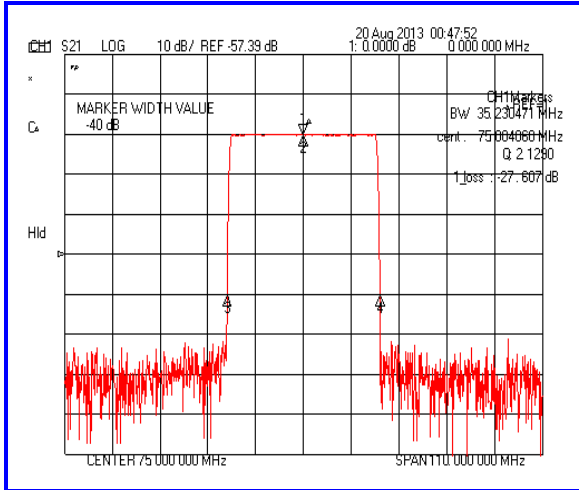

[www.ctech.co.kr](http://www.ctech.co.kr)