

### Typical Performance

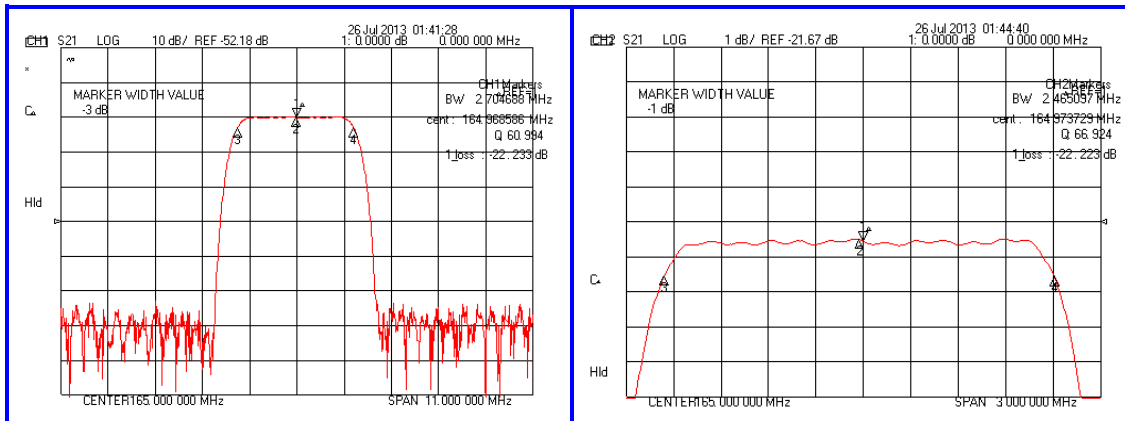

### Specification

Parameter	Unit	Min.	Typ.	Max.
Center Frequency	MHz	164.85	165.00	165.15
Insertion Loss	dB	-	22.50	24.50
1dB Bandwidth	MHz	2.20	2.46	-
3dB Bandwidth	MHz	-	2.70	-
40dB Bandwidth	MHz	-	3.61	3.80
Attenuation	dB	50	55	-
Amplitude Ripple	dB	-	0.30	1.00
Absolute Delay	µsec	-	2.73	-
Group Delay Variation	nsec	-	100	300
Substrate Material & T.C.F	ppm/°C	Quartz & -0.032		
Package	mm	35 X12 (DIP)		

### Package Dimension

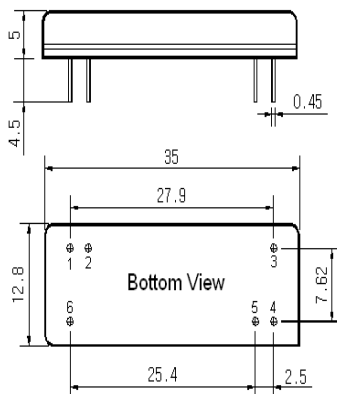

### Matching Configuration

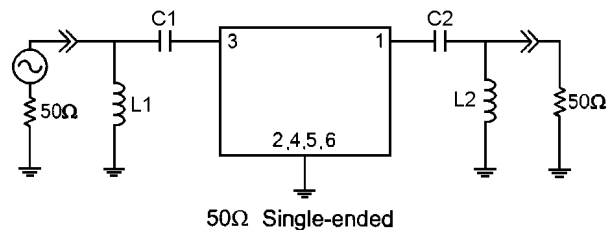

L1=47nH, L2=33nH, C1=30pF, C2=30pF  
 Source / Load Impedance = 50Ω  
 Ambient Temperature = 25°C

Rev0.130729

