

Typical Performance

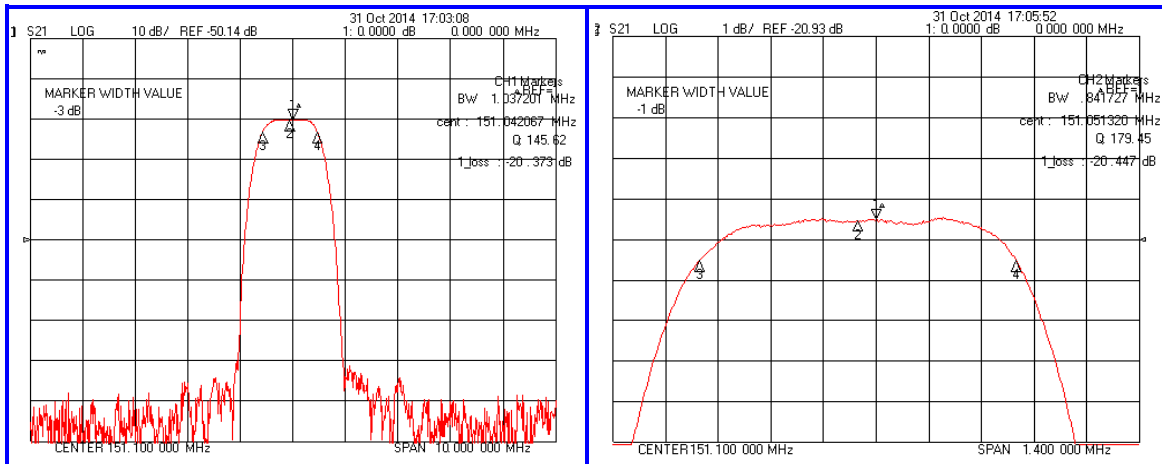

Specification

Parameter	Unit	Min.	Typ.	Max.
Center Frequency	MHz	151.00	151.10	151.20
Insertion Loss	dB	-	20.00	22.00
1dB Bandwidth	MHz	0.75	0.84	-
3dB Bandwidth	MHz	0.95	1.03	-
40dB Bandwidth	MHz	-	1.83	1.95
Passband Ripple	dB	-	0.40	1.00
Group Delay Variation	nsec	-	150	300
Absolute Delay	µsec	-	2.8	-
Ultimate Attenuation	dB	48	53	-
Substrate Material	-	Quartz		
Temperature Coefficient	ppm/°C	-0.03		

Input Power : + 10dBm

Package Dimension

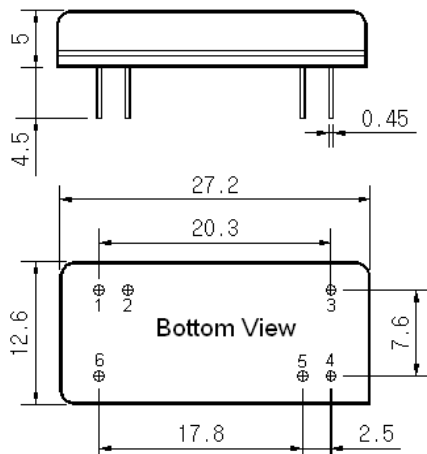

Matching Configuration

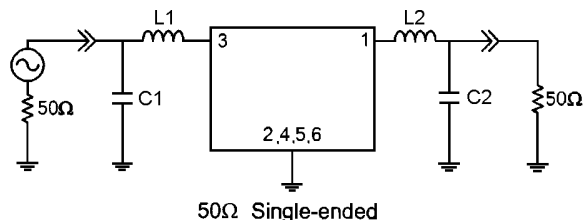

L1=22nH, L2=22nH, C1=36pF, C2=36pF
 Source / Load Impedance = 50Ω
 Ambient Temperature = 25°C

Rev.0 141105

