

Typical Performance

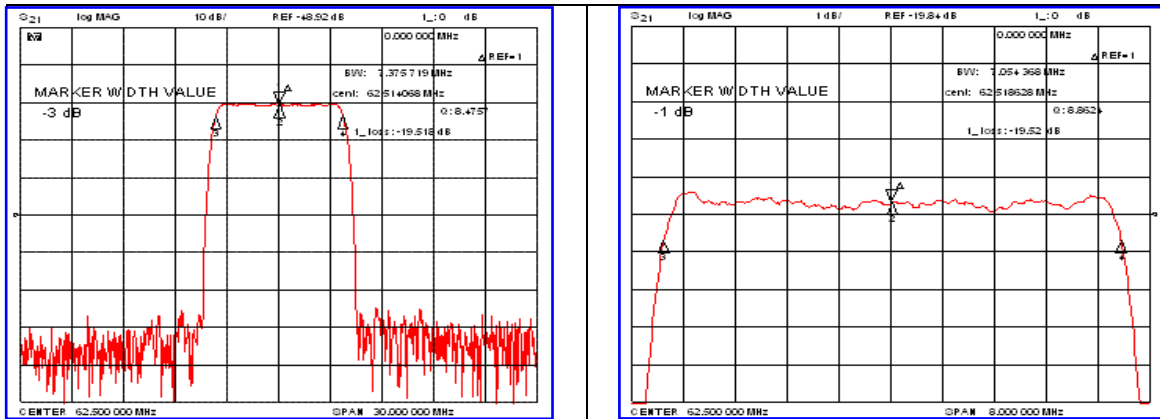

Specification

Parameter	Unit	Min.	Typ.	Max.
Center Frequency	MHz	-	62.50	-
Insertion Loss	dB	-	19.60	22.00
1dB Bandwidth	MHz	-	7.05	-
3dB Bandwidth	MHz	7.25	7.35	-
40dB Bandwidth	MHz	-	8.73	8.80
Passband Ripple($F_c \pm 3.125$ MHz)	dB	-	0.60	1.00
Group Delay Variation	nsec	-	60	120
Absolute Delay	μ sec	-	2.13	-
Ultimate Attenuation	dB	50	55	-
Substrate Material	-	128 - LiNbO ₃		
Temperature Coefficient	ppm/ $^{\circ}$ C	-72		

Package Dimension

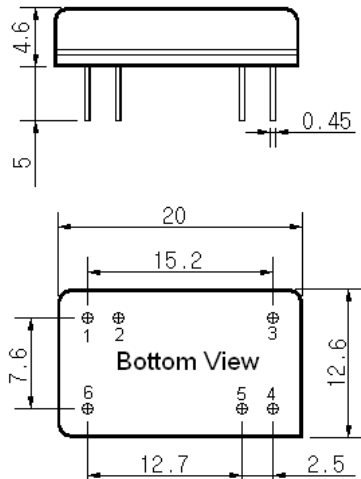

Matching Configuration

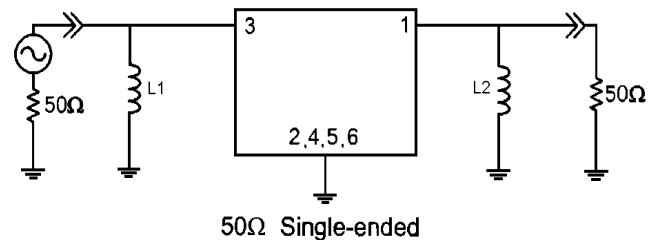

L1=270nH, L2=270nH
Source / Load Impedance = 50Ω
Ambient Temperature = 25 $^{\circ}$ C

Rev0. 081028

