

Typical Performance

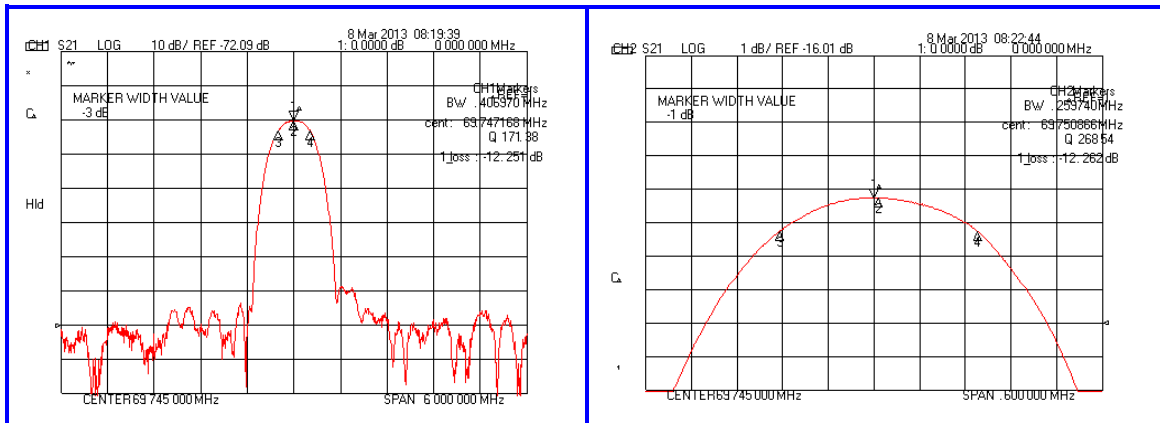

Specification

Parameter	Unit	Min.	Typ.	Max.
Center Frequency	MHz	69.665	69.745	69.825
Insertion Loss	dB	-	12.50	14.00
1dB Bandwidth	MHz	0.17	0.25	-
3dB Bandwidth	MHz	-	0.41	-
40dB Bandwidth	MHz	-	1.01	1.30
Attenuation	dB	45	50	-
Amplitude Ripple	nsec	-	0.40	1.00
Absolute Delay	µsec	-	3.26	-
Group Delay Variation	dB	-	200	400
Substrate Material	-	Quartz		
Temperature Coefficient	ppm/°C	-0.03		
Package	mm	35*12mm(DIP)		

Package Dimension

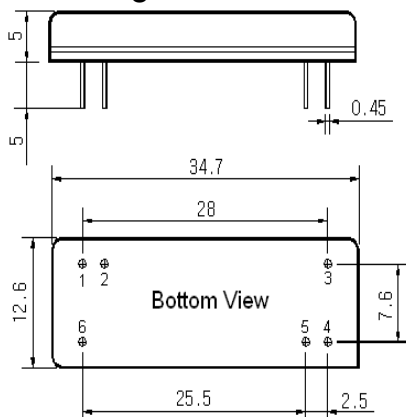

Matching Configuration

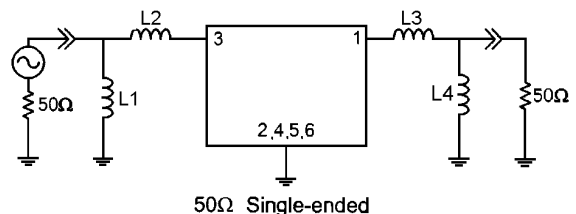

L1=56nH, L2=120nH, L3=82nH, L4=56nH
 Source / Load Impedance = 50Ω
 Ambient Temperature = 25°C

Rev0. 130314

