

Typical Performance

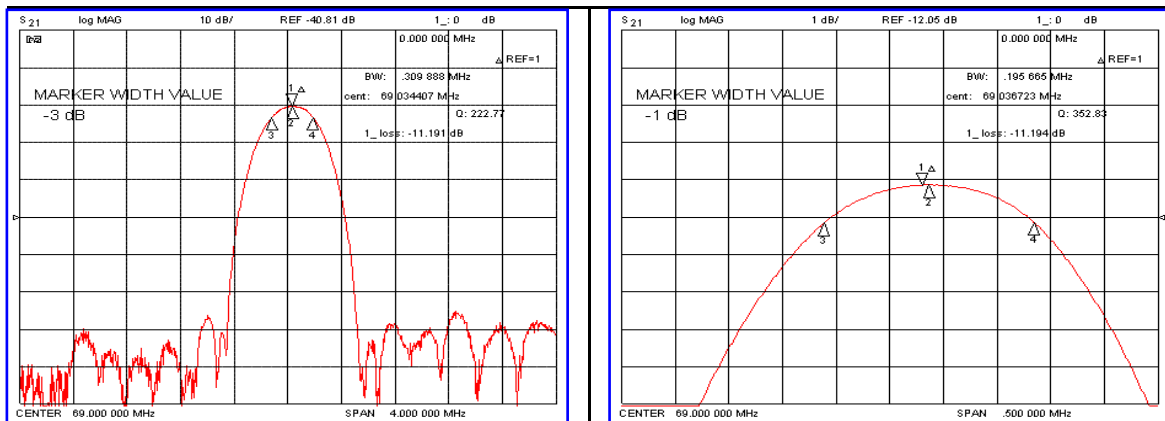

Specification

Parameter	Unit	Min.	Typ.	Max.
Center Frequency (Fc)	MHz	68.92	69.00	69.08
Insertion Loss	dB	-	11.50	14.00
1dB Bandwidth	MHz	-	0.19	-
3dB Bandwidth	MHz	0.25	0.30	-
40dB Bandwidth	MHz	-	0.90	1.20
Passband Ripple	dB	-	0.55	1.00
Group Delay Variation	nsec	-	250	350
Absolute Delay	μsec	-	2.98	-
Ultimate Attenuation	dB	48	53	-
Substrate Material	-	Quartz		
Temperature Coefficient	ppm/°C	-0.03		

Package Dimension

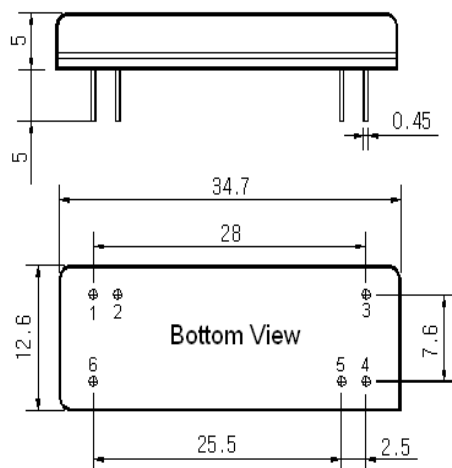

Matching Configuration

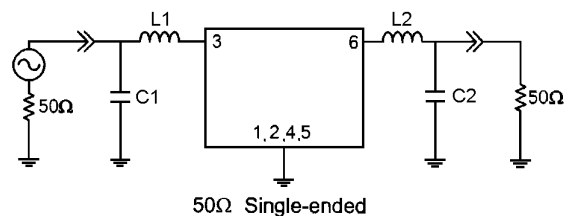

L1= 270nH, L2=220nH, C1=C2=47pF
 Source / Load Impedance = 50Ω
 Ambient Temperature = 25°C

Rev0. 070307

