

Typical Performance

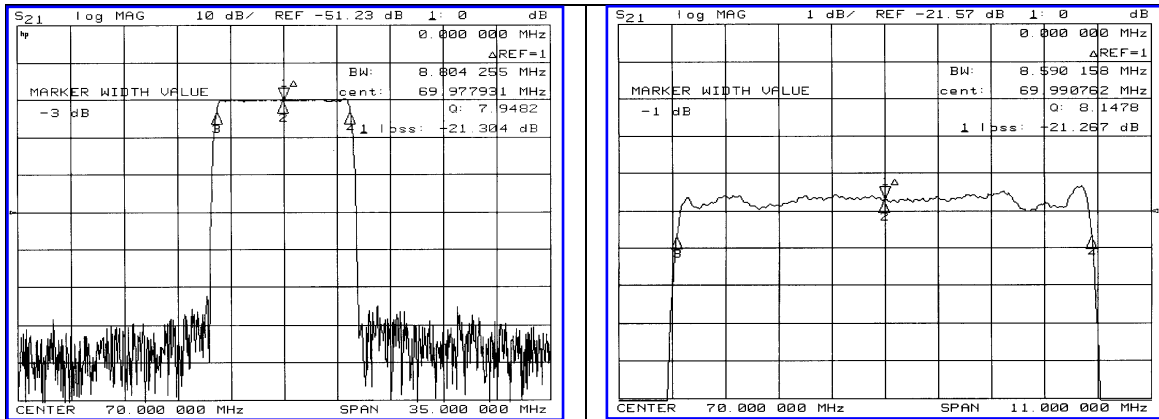

Specification

Parameter	Unit	Min.	Typ.	Max.
Center Frequency	MHz	69.92	70.00	70.08
Insertion Loss	dB	-	21.50	23.00
1dB Bandwidth	MHz	-	8.59	-
3dB Bandwidth	MHz	8.70	8.80	-
45dB Bandwidth	MHz	-	9.72	10.00
Passband Ripple	dB	-	0.65	1.00
Group Delay Variation	nsec	-	78	150
Absolute Delay	µsec	-	3.30	-
Ultimate Attenuation	dB	50	53	-
Substrate Material	-	128-LiNbO ₃		
Temperature Coefficient	ppm/°C	-72		

Package Dimension

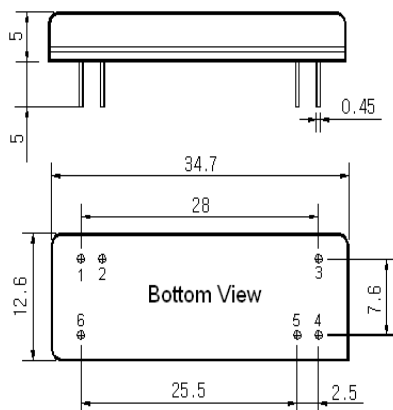

Matching Configuration

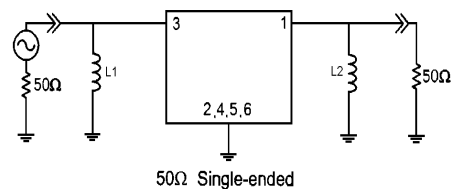

L1=390nH, L2=390nH
 Source / Load Impedance = 50Ω
 Ambient Temperature = 25°C

07/20/2006

