

Typical Performance

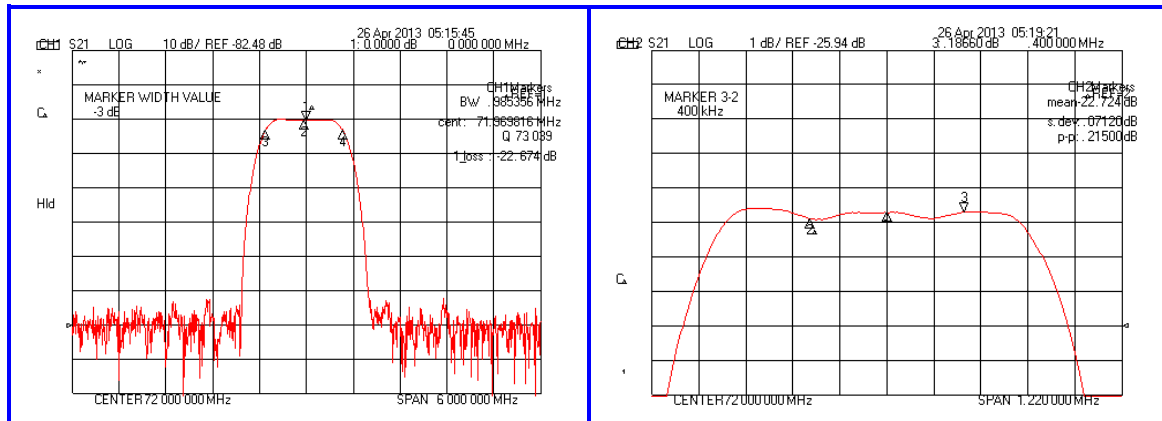

Specification

Parameter	Unit	Min.	Typ.	Max.
Center Frequency	MHz	71.92	72.00	72.08
Insertion Loss	dB	-	22.67	25.50
1dB Bandwidth	MHz	0.60	0.84	-
10dB Bandwidth	MHz	-	1.21	-
20dB Bandwidth	MHz	-	1.38	-
40dB Bandwidth	MHz	-	1.56	1.80
Out of Band Gain	-	-	-	-
Fc ± 0.2MHz ± 600KHz Point	dB	10	37	-
Fc ± 0.2MHz ± 800KHz Point	dB	20	50	-
Amplitude Ripple(Fc ± 0.2MHz)	dB	-	0.21	1.00
Absolute Delay	μsec	-	3.31	-
Group Delay Variation	nsec	-	100	200
Ultimate Attenuation	dB	45	50	-
Substrate Material / T.C.F	ppm/°C	Quartz / -0.032		
Package	mm	35 X 12 (DIP)		

Package Dimension

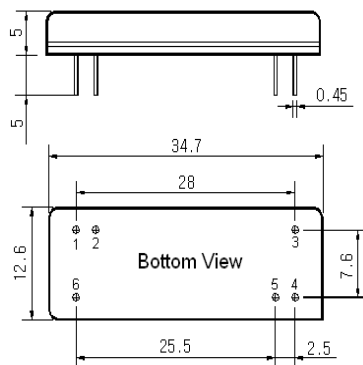

Matching Configuration

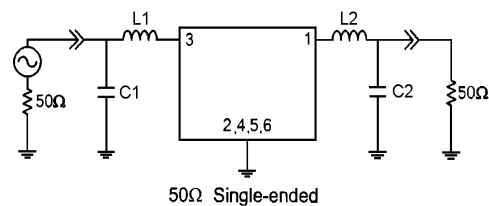

L1=150nH, L2=68nH, C1=130pF, C2=11pF
 Source / Load Impedance = 50Ω
 Ambient Temperature = 25°C

Rev.0 130429

