

Typical Performance

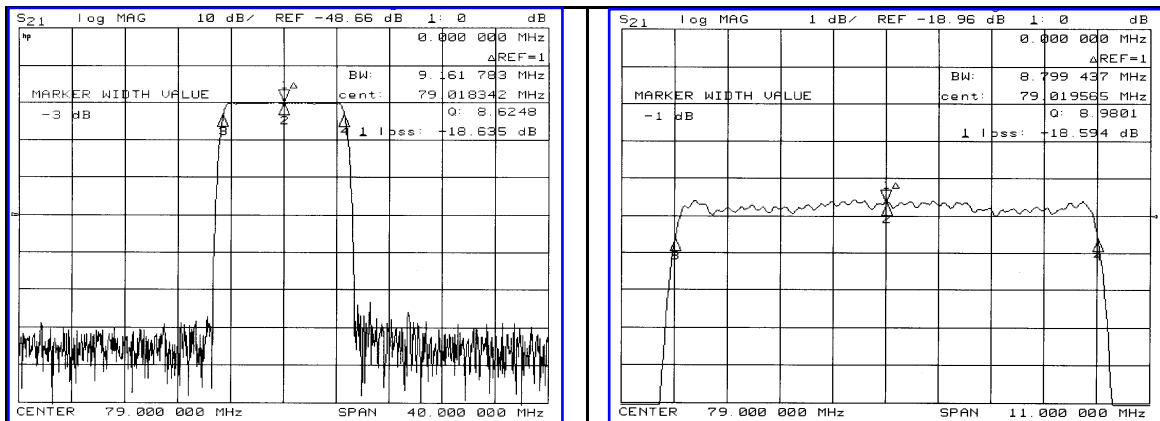

Specification

Parameter	Unit	Min.	Typ.	Max.
Center Frequency (Fc)	MHz	-	79.00	-
Insertion Loss	dB	-	19.00	20.50
1dB Bandwidth	MHz	-	8.79	-
3dB Bandwidth	MHz	9.00	9.16	-
40dB Bandwidth	MHz	-	10.56	10.80
Passband Ripple (Fc±4.22MHz)	dB	-	0.45	1.00
Group Delay Variation (Fc±4.22MHz)	nsec	-	85	130
Absolute Delay	µsec	-	2.16	-
Ultimate Attenuation	dB	50	55	-
Substrate Material	-	128-LiNbO ₃		
Temperature Coefficient	ppm/°C	-72		

Package Dimension

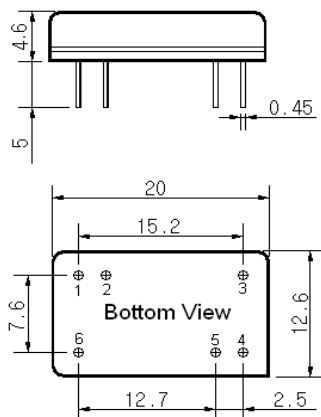

Matching Configuration

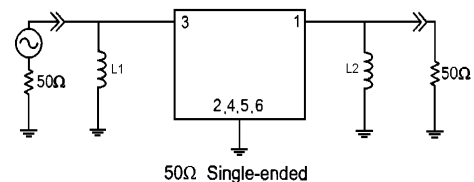

L1=220nH, L2=220nH
 Source / Load Impedance = 50Ω
 Ambient Temperature = 25°C

05/17/2006

