

Typical Performance

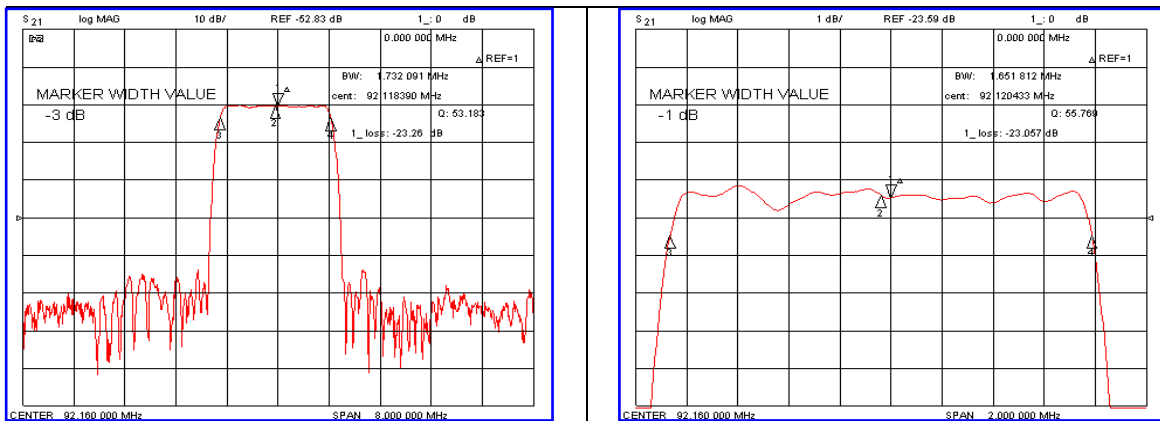

Specification

Parameter	Unit	Min.	Typ.	Max.
Center Frequency	MHz	82.08	92.16	92.24
Insertion Loss	dB	-	23.26	25.00
1dB Bandwidth	MHz	1.55	1.65	-
3dB Bandwidth	MHz	-	1.73	-
10dB Bandwidth	MHz	-	1.86	1.95
30dB Bandwidth	MHz	-	2.03	2.15
Passband Ripple	dB	-	0.66	1.00
Group Delay Variation	nsec	-	220	350
Absolute Delay	usec	-	4.75	-
Ultimate Attenuation	dB	40	43	-
Substrate Material	-	Quartz		
Temperature Coefficient	ppm/°C	-0.03		

Package Dimension

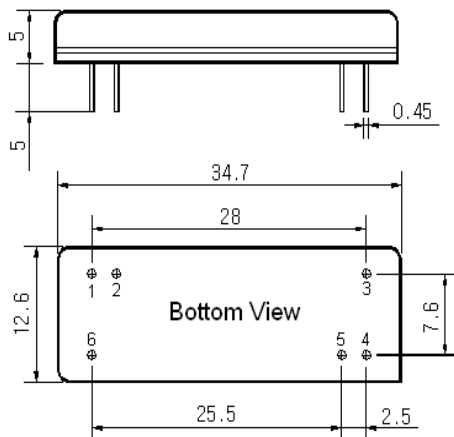

Matching Configuration

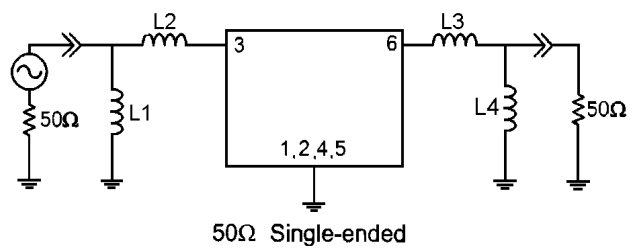

L1=47nH, L2=22nH, L3=15nH, L4=47nH
 Source / Load Impedance = 50Ω
 Ambient Temperature = 25°C

Rev.0 090729

