

Typical Performance

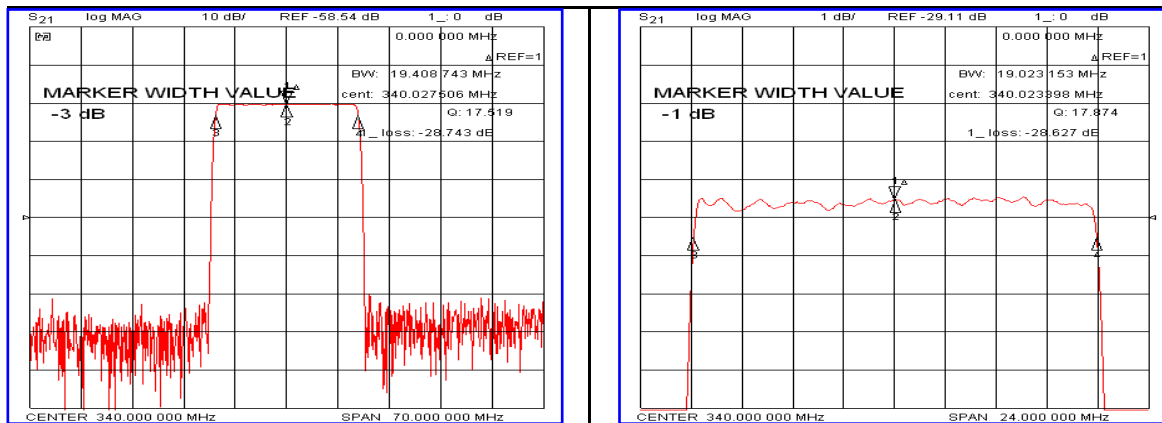

Specification

Parameter	Unit	Min.	Typ.	Max.
Center Frequency	MHz	-	340.00	-
Insertion Loss	dB	-	28.70	30.00
1dB Bandwidth	MHz	18.90	19.02	-
3dB Bandwidth	MHz	-	19.40	-
40dB Bandwidth	MHz	-	21.00	21.20
Passband Ripple($F_c \pm 9.0$ MHz)	dB	-	0.55	1.20
Group Delay Variation($F_c \pm 9.0$ MHz)	dB	-	50	100
Ultimate Attenuation	dB	45	50	-
Absolute Delay	μ sec	-	2.15	-
Substrate Material	-	112-LiTaO ₃		
Temperature Coefficient	ppm/ $^{\circ}$ C	-20		

Package Dimension

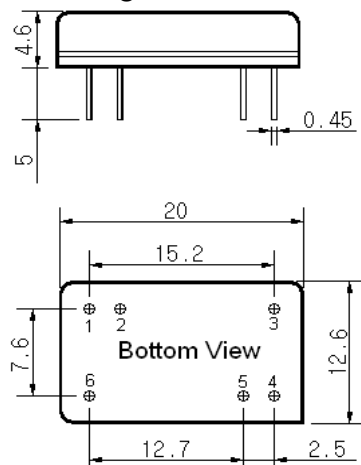

Matching Configuration

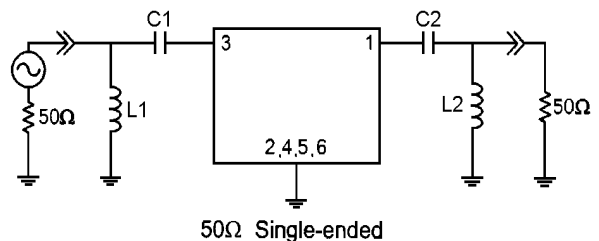

L1=10nH, L2=10nH, C1=20pF, C2=22pF
 Source / Load Impedance = 50 Ω
 Ambient Temperature = 25 $^{\circ}$ C

Rev 0. 120327

