

Typical Performance

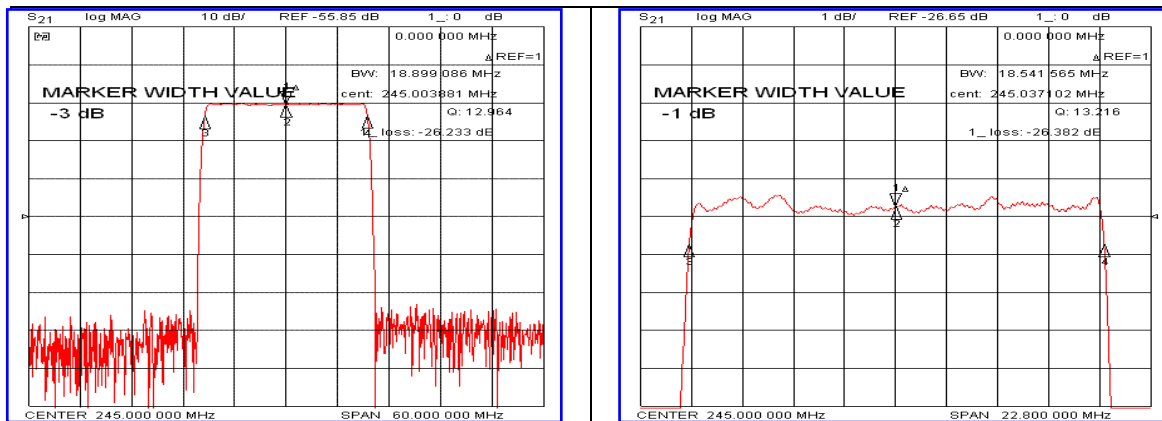

Specification

Parameter	Unit	Min.	Typ.	Max.
Center Frequency	MHz	-	245.00	-
Insertion Loss	dB	-	26.50	28.50
1dB Bandwidth	MHz	18.40	18.54	-
3dB Bandwidth	MHz	-	18.89	-
40dB Bandwidth	MHz	-	20.45	20.60
Passband Ripple(Fc ± 9MHz)	dB	-	0.60	1.20
Group Delay Variation(Fc ± 9MHz)	nsec	-	40	100
Absolute Delay	µsec	-	2.24	-
Ultimate Attenuation	dB	47	53	-
Substrate Material	-	112-LiTaO ₃		
Temperature Coefficient	ppm/°C	-20		

Package Dimension

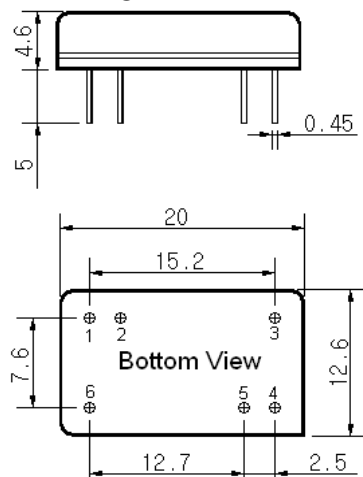

Matching Configuration

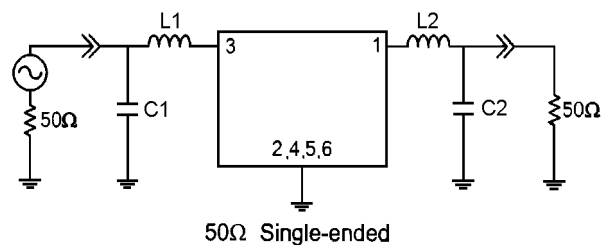

L1=15nH, L2=15nH, C1=36pF, C2=43pF
 Source / Load Impedance = 50Ω
 Ambient Temperature = 25°C

Rev1. 121019

