

Typical Performance

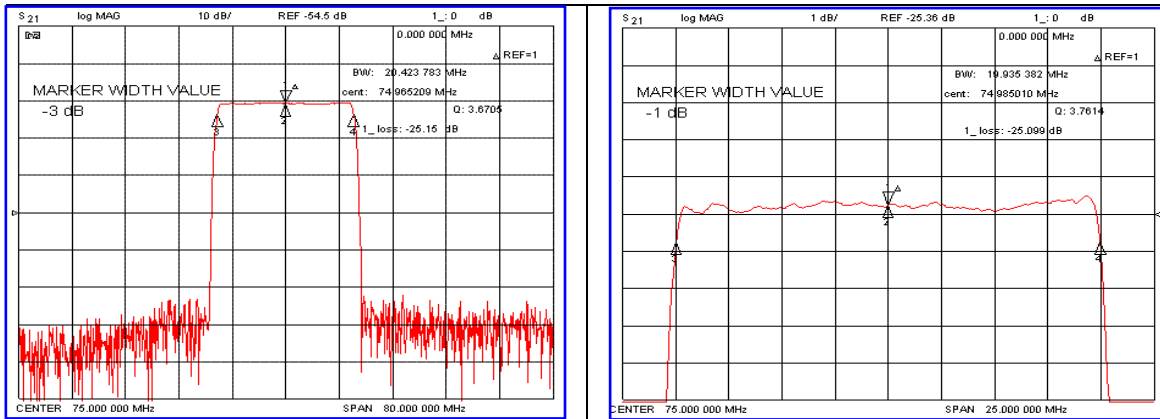

Specification

Parameter	Unit	Min.	Typ.	Max.
Center Frequency	Mhz	-	75.00	-
Insertion Loss	dB	-	25.20	26.50
1dB Bandwidth	Mhz	-	19.93	-
3dB Bandwidth	Mhz	20.30	20.42	-
50dB Bandwidth	Mhz	-	22.59	22.70
Passband Ripple	dB	-	0.50	1.00
Group Delay Variation	nsec	-	30	50
Absolute Delay	µsec	-	1.56	-
Ultimate Attenuation	dB	50	55	-
Substrate Material	-	128-LN		
Temperature Coefficient	ppm/°C	-72		

Package Dimension

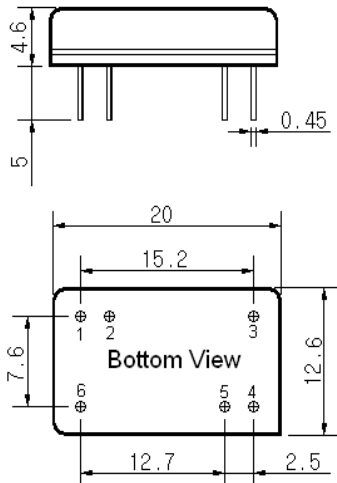

Matching Configuration

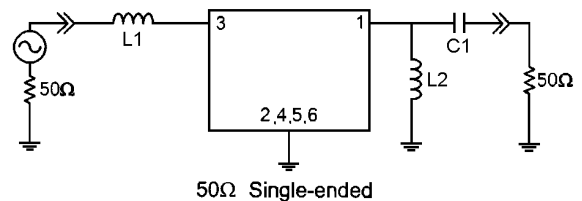

L1=82nH, L2=120nH, C1=36pF
 Source / Load Impedance = 50Ω
 Ambient Temperature = 25°C

Rev 0. 070504

