

Typical Performance

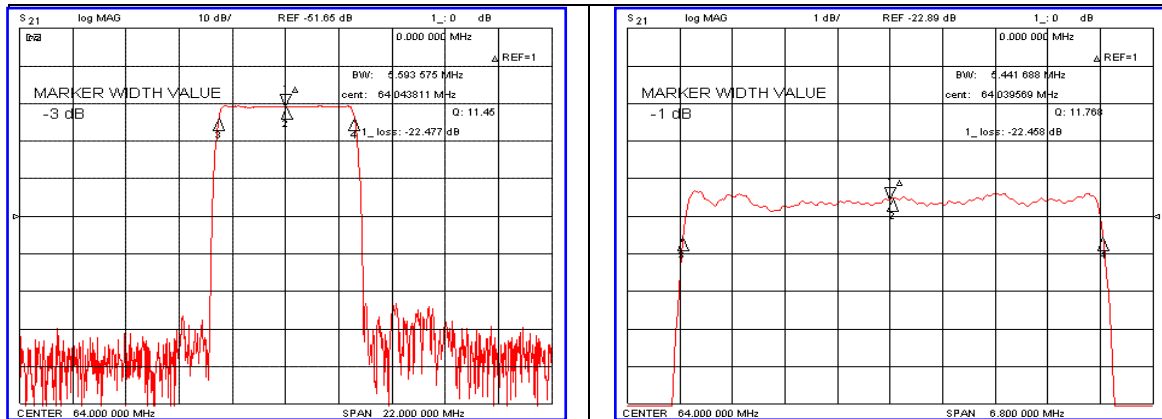

Specification

Parameter	Unit	Min.	Typ.	Max.
Center Frequency	MHz	63.92	64.00	64.08
Insertion Loss	dB	-	22.50	25.00
1dB Bandwidth	MHz	-	5.44	-
3dB Bandwidth	MHz	5.50	5.59	-
20dB Bandwidth	MHz	-	6.05	6.10
40dB Bandwidth	MHz	-	6.25	-
Passband Ripple	dB	-	0.60	1.00
Group Delay Variation	nsec	-	100	200
Absolute Delay	μsec	-	4.20	-
Ultimate Attenuation	dB	50	53	-
Substrate Material	-	YZ-LiNbO ₃		
Temperature Coefficient	ppm/°C	-94		

Package Dimension

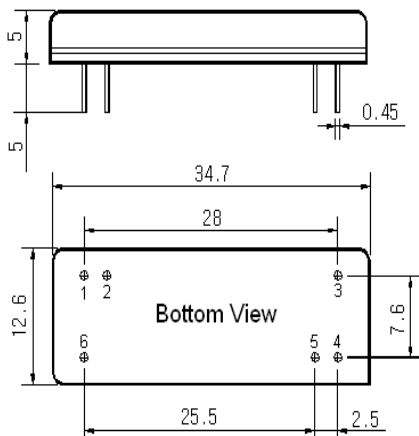

Matching Configuration

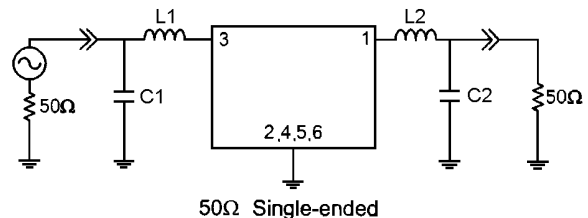

L1=L2=47nH, C1=C2=18pF
 Source / Load Impedance = 50Ω
 Ambient Temperature = 25°C

Rev0.071203

