

Typical Performance

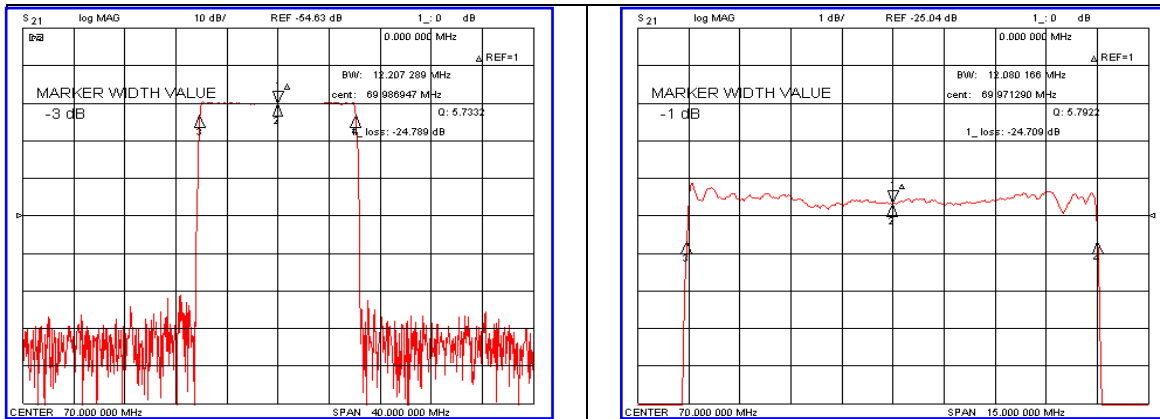

Specification

Parameter	Unit	Min.	Typ.	Max.
Center Frequency	MHz	69.92	70.00	70.08
Insertion Loss	dB	-	25.00	26.50
1dB Bandwidth	MHz	12.00	12.08	-
3dB Bandwidth	MHz	-	12.20	-
40dB Bandwidth	MHz	-	12.78	12.88
Passband Ripple	dB	-	0.82	1.20
Group Delay Variation	nsec	-	100	200
Absolute Delay	usec	-	4.50	-
Ultimate Attenuation	dB	47	50	-
Substrate Material	-	YZ-LiNbO ₃		
Temperature Coefficient	ppm/°C	-94		

Package Dimension

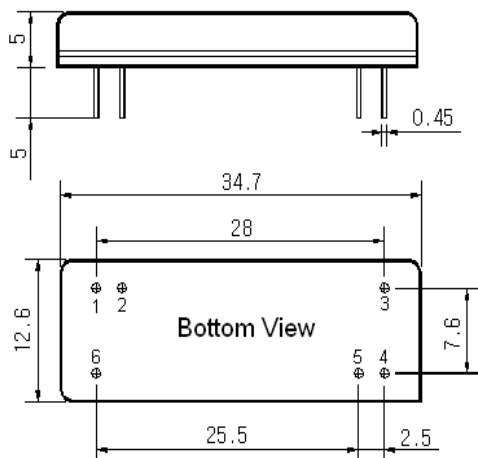

Matching Configuration

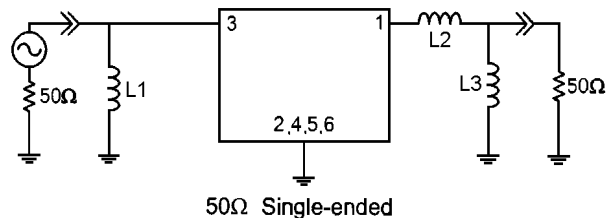

L1=150nH, L2=39nH, L3=150nH
 Source / Load Impedance = 50Ω
 Ambient Temperature = 25°C

Rev.0 091008

