

Typical Performance

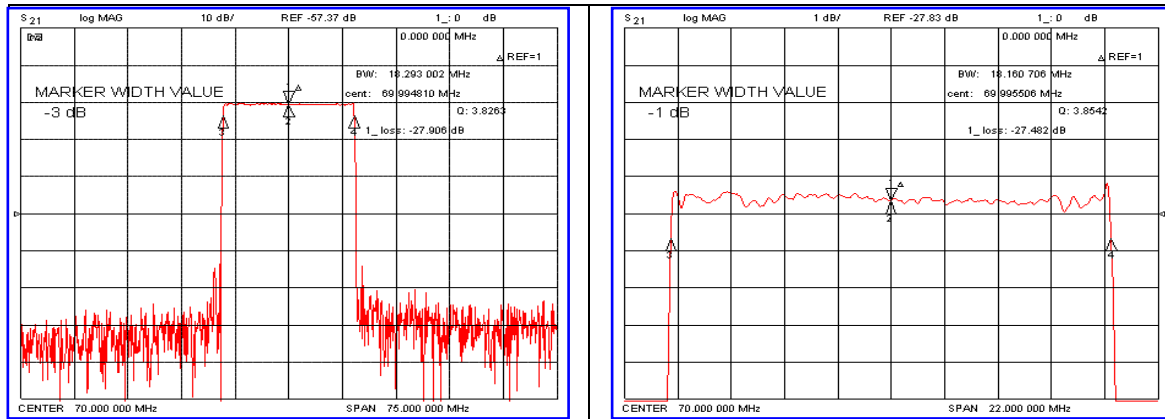

Specification

Parameter	Unit	Min.	Typ.	Max.
Center Frequency (Fc)	MHz	69.96	70.00	70.04
Insertion Loss	dB	-	27.90	-
1dB Bandwidth	MHz	18.00	18.16	-
3dB Bandwidth	MHz	-	18.29	-
35dB Bandwidth	MHz	-	18.91	-
40dB Bandwidth	MHz	-	18.95	19.00
Passband Ripple	dB	-	0.75	1.00
Group Delay Variation	nsec	-	70	150
Absolute Delay	µsec	-	3.81	-
Ultimate Attenuation	dB	-	45	-
Substrate Material	-	128-LiNbO ₃		
Temperature Coefficient	ppm/°C	-72		

Package Dimension

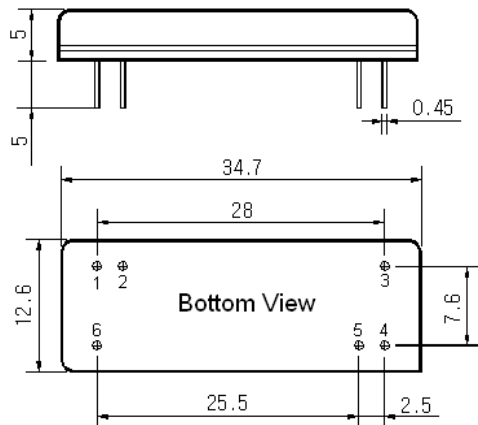

Matching Configuration

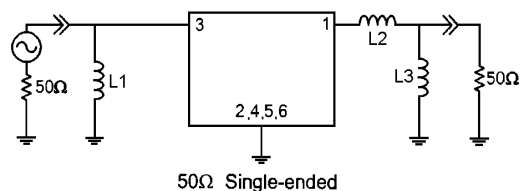

L1=220nH, L2=18nH, L3=220nH
Source / Load Impedance = 50Ω
Ambient Temperature = 25°C

Rev0. 070215

