

Typical Performance

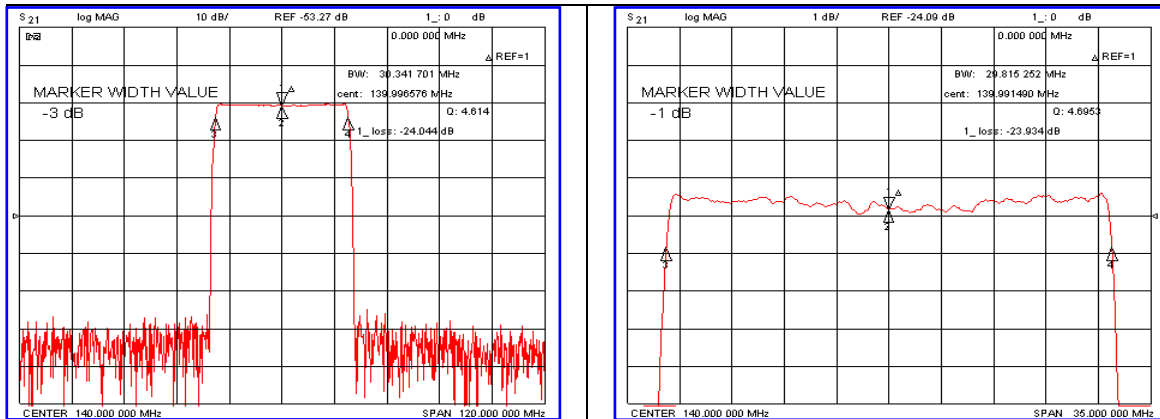

Specification

Parameter	Unit	Min.	Typ.	Max.
Center Frequency	MHz	139.80	140.00	140.20
Insertion Loss	dB	-	24.10	25.50
1dB Bandwidth	MHz	-	29.81	-
3dB Bandwidth	MHz	30.00	30.34	-
40dB Bandwidth	MHz	-	32.62	33.00
Passband Ripple	dB	-	0.55	1.00
Group Delay Variation	nsec	-	30	50
Absolute Delay	µsec	-	1.42	-
Ultimate Attenuation	dB	50	54	-
Substrate Material	-	128-LiNbO ₃		
Temperature Coefficient	ppm/°C	-72		

Package Dimension

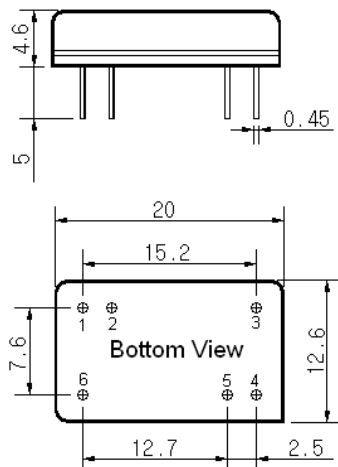

Matching Configuration

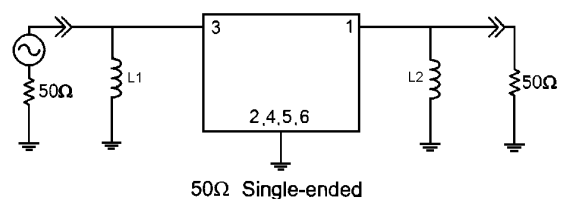

L1=150nH, L2=150nH
 Source / Load Impedance = 50Ω
 Ambient Temperature = 25°C

Rev0.071024

