

Typical Performance

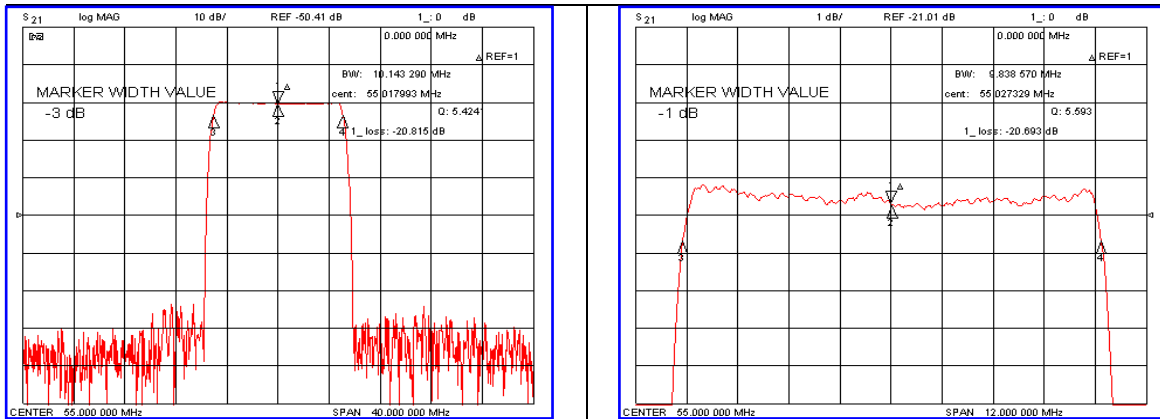

Specification

Parameter	Unit	Min.	Typ.	Max.
Center Frequency	MHz	-	55.00	-
Insertion Loss	dB	-	21.00	23.00
1dB Bandwidth	MHz	9.70	9.83	-
3dB Bandwidth	MHz	-	10.14	-
40dB Bandwidth	MHz	-	11.47	11.60
Passband Ripple($F_c \pm 4.52$ MHz)	dB	-	0.64	1.00
Group Delay Variation($F_c \pm 4.52$ MHz)	nsec	-	45	100
Absolute Delay	μ sec	-	2.20	-
Ultimate Attenuation	dB	50	55	-
Substrate Material	-	128- LiNbO ₃		
Temperature Coefficient	ppm/ $^{\circ}$ C	-72		

Package Dimension

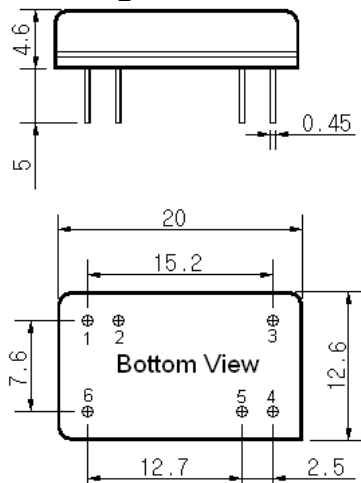

Matching Configuration

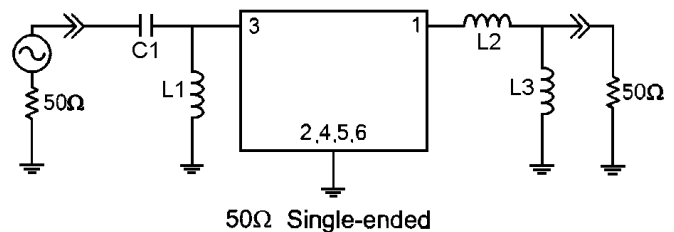

L1=180nH, L2=100nH, L3=220nH, C1=47pF
 Source / Load Impedance = 50 Ω
 Ambient Temperature = 25 $^{\circ}$ C

Rev0. 090717

