

Typical Performance

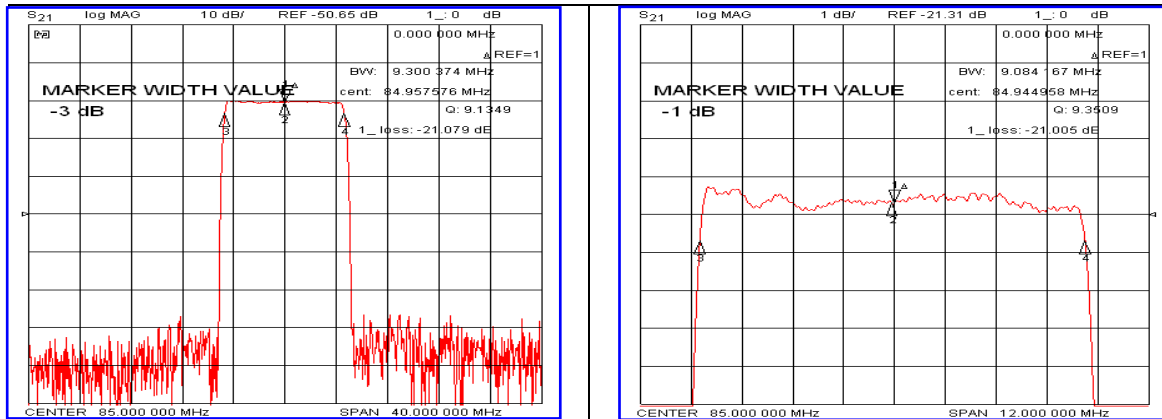

Specification

Parameter	Unit	Min.	Typ.	Max.
Center Frequency	MHz	84.90	85.00	85.10
Insertion Loss	dB	-	21.20	23.50
1dB Bandwidth	MHz	9.00	9.08	-
3dB Bandwidth	MHz	-	9.30	-
20dB Bandwidth	MHz	-	9.92	10.05
40dB Bandwidth	MHz	-	10.20	-
Passband Ripple	dB	-	0.68	1.20
Absolute Delay	usec	-	3.48	-
Ultimate Attenuation	dB	45	50	-
Substrate Material	-	Yz-LiNbO ₃		
Temperature Coefficient	ppm/°C	-94		

Package Dimension

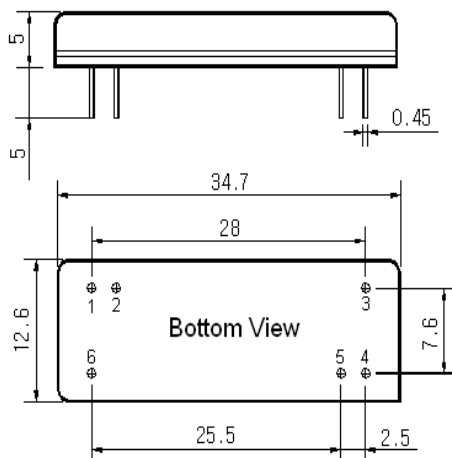

Matching Configuration

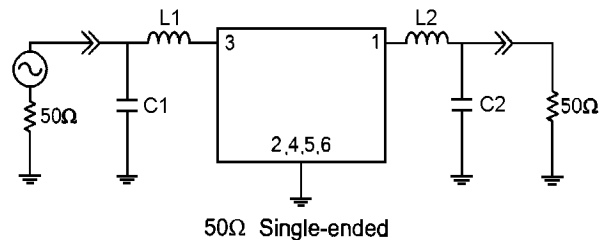

L1=68nH, L2=68nH, C1=33pF, C2=39pF
 Source / Load Impedance = 50Ω
 Ambient Temperature = 25°C

Rev.0 120424

